

BPA POWER PRODUCTS CATALOG

SEPTEMBER 1999

BPA POWER PRODUCTS CATALOG



To Our Customers

This version of the BPA Power Products Catalog includes updated descriptions of each of the core Subscription products and many examples of the power products offered by BPA's Power Business Line. The Product Catalog can be used as a tool to assist you in working with your Account Executive to determine the type of products that will best serve your power needs in the 21st century. The selection of products requires in-depth knowledge of your power supply needs, product features, and applicability. Please contact your Account Executive for assistance in selecting or developing the products that will meet your objectives.

Categories of Products, Availability, and Applicable Rates

The Power products are separated into three distinct categories:

- (1) **Core Subscription Products** were designed for customers that request net firm requirements load service to serve regional consumer load. A customer that is interested in the standard version of a core product or service (described in the catalog) may purchase the undelivered product or service at the applicable posted rate (see BPA's 2002 Proposed Wholesale Power Rate Schedules).
- (2) **Customized Subscription Products** are available for customers that request net firm requirements load service to serve regional consumer load (Core Products) and that want additional flexibility to shape their purchases from BPA in order to optimize their resource operations. These products will have bilaterally negotiated pricing for all modifications to Core Products and any additional products and services customers wish to purchase. The price for customized products that differ from the Core Products will be negotiated under the Firm Power Products and Services (FPS-96) Rate Schedule. Slice of the System purchasers will pay a corresponding percentage of BPA's Power Business Line (PBL) revenue requirement without adjustment for secondary revenue credits.
- (3) **Non-Subscription Products** generally include power products and services that BPA may sell to a customer in the wholesale marketplace. The bilateral product descriptions in the catalog are examples of products and services BPA can provide. These or other commodity type products marketed by BPA's trading floor may have limited availability. These products and services will be offered under the (FPS-96) Rate Schedule.

Updates to the Catalog

Customers will note that certain changes have been made to some product descriptions. These changes incorporate BPA's current policy guidance.

Changes of note are:

The addition of a new product, Generation Management Services, which is designed for utilities with non-dispatchable generating resources or customers that wish to purchase management and dispatch

BPA POWER PRODUCTS CATALOG

services from BPA. The Partial Service products have been expanded to better achieve the objective of equitable comparability with Full Service. For example, the Block Purchase amount may increase over time if the customer's net requirements increase and the Dedicated Resource concept has been incorporated as a version of Simple Actual Partial Service.

To alleviate some product overlap, the Insurance product and Block Flexibility product have been removed from the current product list.

BPA's green product has been renamed Environmentally Preferred Power.

BPA will post the Power Product Team Report on its external web page in early September 1999. The report will provide more detail about the changes.

Other Public Processes:

The Power Products catalog describes the proposed products BPA will offer to its customers. Because a few of the critical processes are still ongoing, the customer is reminded that while the products are considered final, these unresolved issues will affect BPA's final offer. The issues include:

- 2002 Wholesale Power Rate Case;
- Slice of the System;
- 5(b)/9(c) (Net Requirements) Policy;
- Eligibility for Service, and
- Other Policy Guidance.

Transmission Service:

All products listed in the Power Products Catalog are priced on an undelivered basis. This means that the customer is responsible for acquiring transmission and associated ancillary services to deliver purchased power to load. Under certain circumstances, if requested, BPA will act as the customer's "designated agent" in order to perform the activities/responsibilities on behalf of the transmission contract holder (for more details contact your PBL Account Executive).

FOR FURTHER INFORMATION ON THE CATALOG, CONTACT: Ms. Carolyn A. Richardson,
Power Business Line at (503) 230-5163.

For More Information about BPA's Power Products, visit our website at www.bpa.gov/Power/Products.



BPA POWER PRODUCTS CATALOG

<i>PRODUCTS</i>	<i>Table Of Contents</i>	<i>Page</i>
CORE SUBSCRIPTION PRODUCTS		1
Full Service		2
Actual Partial Service (Simple/Complex)		6
<i>Detailed Description: Actual Partial Service (Simple/Complex)</i>		10
<i>Detailed Description: Actual Partial Service with Dedicated Resource(s)</i>		14
Factoring		16
<i>Detailed Description: Factoring Service and Benchmark Methodology</i>		17
Block Partial Service		24
<i>Detailed Description: Block Partial Service</i>		25
Block with Shaping Capacity		28
<i>Detailed Description: Block with Shaping Capacity</i>		29
Block with Factoring		32
CUSTOMIZED SUBSCRIPTION PRODUCTS		34
Variable Load Factor		35
Slice of the System		36
Environmentally Preferred Power		42
NON-SUBSCRIPTION PRODUCTS		44
Bilateral Products & Services		45
<i>Power - Firm, Secondary, Commodity (including loss compensation)</i>		45
<i>Capacity w/out Energy</i>		46
<i>Storage</i>		47
<i>Resource Factoring</i>		49
<i>Preschedule Change Rights</i>		50
<i>Displacement</i>		51
<i>Scheduling Services</i>		52
Reserves, Resource Support		53-55
<i>Supplemental AGC</i>		53
<i>Contingency (Operating) Reserves</i>		54
<i>Forced Outage Reserves</i>		55
Complements to Core Products		56-60
<i>Remarketing Service</i>		56
<i>Generation Management Service</i>		58
APPENDIX A: Commonly Used Acronyms		1
APPENDIX B: Core Product Billing Factors		4



CORE SUBSCRIPTION PRODUCTS

BPA POWER PRODUCTS CATALOG

<i>Core Subscription Product</i>	<i>Full Service</i>
General	<p>The Full Service product is a core Subscription product. This product is available to purchasers who have a right to purchase power from BPA to meet their entire Total Retail Load (TRL) requirements needs. This standard product will be sold under a posted rate schedule.</p> <p>This product provides all the firm power the customer needs to meet TRL.</p>
Availability	<p>This product is intended for customers who have a right to purchase from BPA under the Pacific Northwest Electric Power Planning and Conservation Act (Regional Act), section 5(b). Full Service customers are those who choose to purchase all of their power needs from BPA, including those who have small non-dispatchable generating resources which meet BPA's criteria for measured amount net billing treatment.</p> <p>The maximum amounts of this product that the customer is entitled to purchase will be determined consistent with BPA's policy on Determination of Net Resources.</p>
Product Description	<p>The Full Service product provides all firm power necessary to meet a customer's actual loads in excess of the customer's small non-dispatchable generating resources, consumer-owned small non-dispatchable generating resources and Columbia Storage Power Exchange.</p> <p>This service includes Heavy Load Hour (HLH) energy, Light Load Hour (LLH) energy, demand (peaking and capacity), and any shaping necessary to cover load variations in TRL due to temperature changes and load loss/growth except when due to retail access load gain or loss.</p>
Rates and Billing Factor(s)	<p>See Core Product Billing Factors in this catalog, Appendix B. Refer to BPA's 2002 Proposed Wholesale Power Rate Schedule for applicable posted rates.</p>
Purchase Period	<p>The purchase period is 3 to 20 years, beginning October 1, 2001 (or another term consistent with the Rate Schedules).</p>



BPA POWER PRODUCTS CATALOG

<i>Core Subscription Product</i>	<i>Full Service</i>
Pricing Construct	Cost-based pricing is fixed for a period of 3 to 5 years.
Continuing Payment Obligation	<p>BPA will accept the risk of retail access load loss for Full Service customer loads with a three-year initial purchase commitment by the customer. BPA will also accept the risk of state mandated retail access load loss for any Full Service customer loads if such purchaser agrees not to participate in any form of voluntary retail access.</p> <p>A customer that participates in voluntary retail access is obligated to pay BPA the amount they would have paid for the lost load at the original Priority Firm (PF) rate. The customer may purchase one of the retail access mitigation products or employ a contract mitigation measure to help alleviate or lessen this obligation.</p> <p>Customers are required to provide BPA with retail load loss and load gain data necessary to execute the power sales contract. The data must conform to industry standards.</p>
Resources: Customer Owned	<p>The Full Service product will absorb the actual output of customer resources which meet BPA’s criteria for declared nonfirm output resources</p> <p>See the Generation Management Service (GMS) product for a description of BPA’s criteria related to the size of customer owned resources</p> <p>Customers with resources that do not meet BPA’s criteria as declared nonfirm output resources, including consumer-owned generating resources acquired after Subscription opens, may remain Full Service customers by purchasing the GMS product described below.</p>



BPA POWER PRODUCTS CATALOG

<i>Core Subscription Product</i>	<i>Full Service</i>
Resources: Non Utility Owned	<p>For purchasers of Full Service or Actual Partial Service Measured Amount Netting means, the measured hourly amounts of power taken will be the measured load net of the actual output of named resources</p> <p>Non-utility owned resources in place under power sales contracts which were executed prior to the subscription process will be treated the same as declared utility-owned resources that qualify for measured amount netting treatment in the billing process.</p> <p>The output of non-utility owned not in place under pre-subscription contracts will not be eligible for measured amount netting unless: (1) the resource size is less than 3 MW based on the nameplate rating or (2) BPA, the customer, and the resource owner mutually agree.</p> <p>If such resources are not eligible for measured amount netting, billing will treat the output the same as if it were an incoming retail access power delivery schedule. Product billing amounts will not be reduced to reflect such output and separate energy imbalance accounting may be required.</p>
Transmission and Ancillary Services	<p>Transmission delivery and ancillary services are not included in this product except as noted below. Any energy imbalance that occurs as a result of retail access load loss is not covered by this product.</p>
Transmission Losses and Service Related to Actual Load	<p>Transmission losses are included in this product.</p> <p>For customers within BPA’s control area or served by General Transfer Agreement, the product serves actual hour by hour entitlement as measured after the fact.</p>
General Transfer Agreements (GTA)	<p>BPA will continue to provide and pay for transfer service under existing transfer agreements for the term of the new Subscription contracts or until the advent of a regional transmission organization, whichever occurs first.</p>



<i>Core Subscription Product</i>	<i>Full Service</i>
Retail Access Load Gain	The customer may purchase additional power at the appropriate PF rate with adjustments.
Retail Access Load Loss	See Continuing Payment Obligation. The customer may select one of the retail access mitigation measures for non-state mandated retail access load loss.
Associated Services	Generation Management Services (GMS), to compensate BPA for absorbing variable output of customer resources, is not required for this product up to the 3 MWs each or 6 MWs total stated megawatt limit. Customers with resources that are greater than 3 MWs each, 6 MWs total but less than 15 MWs each, 50 MWs total based on the nameplate classification, may qualify for Full Service by purchasing the appropriate GMS products and services. The amounts and types of GMS would be determined on a resource specific basis. See the description of GMS in this catalog. Small non-dispatchable resources up to 3 MWs each or 6 MWs total within the customer's metering boundary will be treated as load fluctuations.
Interaction with other products	Since this product includes a component to meet load variations, it should not be combined with any other product that has built-in load variations. This product may not be purchased in conjunction with any other core Subscription product.

BPA POWER PRODUCTS CATALOG

<i>Core Subscription Product</i>	<i>Actual Partial Service – Simple and Complex versions</i>
General	The Actual Partial Service product versions are core Subscription products. They are available to purchasers who have a right to purchase power from BPA to meet their net requirements. This standard product will be sold under a posted rate schedule.
Availability	<p>These products are intended for customers who have a right to purchase under Regional Act, section 5(b) from BPA. These products are intended for customers who have contractual or generating resources with firm capabilities and therefore, require a product other than Full Service. These products provide service to net actual load in a manner equitably comparable to the Full Service product.</p> <p>The maximum amounts of this product that the customer is entitled to purchase will be determined consistent with BPA’s policy on determination of net requirements.</p>
Product Description	<p>These products provide all firm power necessary to meet a customer’s actual loads in excess of its declared resource amounts and the output of small non-dispatchable resources which meet BPA’s criteria for measured amount net treatment for billing.</p> <p>This service includes HLH energy, LLH energy, demand (peaking and capacity), and any shaping necessary to cover load variations in TRL due to temperature changes and load loss/growth due to increases except when due to retail access load gain or loss.</p>
Rates and Billing Factor(s)	See Core Product Billing Factors in the catalog, Appendix B. Refer to BPA’s 2002 Proposed Wholesale Power Rate Schedule for applicable posted rates.
Purchase Period	The purchase period is 3 to 20 years, beginning October 1, 2001 (or another term consistent with the Rate Schedules).
Pricing Construct	Cost-based pricing is fixed for a period of 3 to 5 years.



<i>Core Subscription Product</i>	<i>Actual Partial Service – Simple and Complex versions</i>
<p>Continuing Payment Obligation</p>	<p>BPA will accept the risk of retail access load loss for Actual Partial Service customer loads with a three-year initial purchase commitment by the customer. BPA will also accept the risk of state mandated retail access load loss for a purchaser under the Dedicated Resource version if such purchaser agrees not to participate in any form of voluntary retail access.</p> <p>A customer that participates in voluntary retail access is obligated to pay BPA the amount they would have paid for the lost load at the original PF rate. The customer may purchase one of the retail access mitigation products or employ a contract mitigation measure to help alleviate or lessen this obligation.</p> <p>All customer purchase obligations and rights at BPA’s PF rates are contingent on BPA’s policy on sections 5(b) and 9(c) of the Regional Act P.L. 96-501.</p> <p>Customers are required to provide BPA with retail load loss and load gain data necessary to execute the power sales contract.</p>
<p>Resources: Customer-Owned</p>	<p>Refer to the Partial Service product descriptions, especially detailed description of Customer Resource Declaration Parameters).</p> <p>The Actual Partial Service product will absorb the actual output of customer resources which meet BPA’s criteria for measured amount netting in the billing process.</p> <p>See the GMS product for a description of BPA’s criteria related to the size of customer owned resources.</p> <p>Customers with resources that do not meet BPA’s criteria as declared nonfirm output resources, including consumer-owned generating resources acquired after Subscription opens, may remain Full Service customers by purchasing the Generation Management Service (GMS) product.</p>



<i>Core Subscription Product</i>	<i>Actual Partial Service – Simple and Complex versions</i>
<p>Resources: Non-Utility Owned</p>	<p>Non-utility owned resources in place under power sales contracts which were executed prior to the subscription process will be treated the same as declared utility-owned resources that qualify for measured amount netting treatment in the billing process.</p> <p>The output of Non-utility owned resources that were not in place under pre-Subscription contracts will not be eligible for measured amount netting unless: (1) the resource size is less than 3 MWs, based on nameplate rating; or (2) BPA, the customer, and the resource owner mutually agree.</p> <p>If such resources are not eligible for measured amount netting, billing under this product will treat the output the same as if it were an incoming retail access power delivery schedule. Product billing amounts will not be reduced to reflect such output and separate energy imbalance accounting may be required.</p>
<p>Transmission and Ancillary Services</p>	<p>Transmission delivery and ancillary services are not included in this product. Any energy imbalance that occurs as a result of retail access load loss is not covered by this product.</p>
<p>Transmission Losses and Service Related to Actual Load</p>	<p>Transmission losses are included in this product.</p> <p>For customers within the BPA control area or served by General Transfer Agreement, the product serves actual hour by hour entitlement as measured after the fact.</p>
<p>General Transfer Agreements (GTA)</p>	<p>See the final GTA policy in the Power Subscription Strategy for specific details.</p> <p>BPA will continue to provide and pay for transfer service under existing transfer agreements for the earlier of the term of the new subscription contracts or the advent of a Regional Transmission Organization, whichever occurs first.</p>



<i>Core Subscription Product</i>	<i>Actual Partial Service – Simple and Complex versions</i>
Load Growth	Load growth for Actual Partial Service customers is included. Note: New Large Single Loads (NLSL) will be subject to the NR rate.
Load Loss	The Actual Partial Service product covers decreases in a customer’s total retail load such as: plant closures, demolition, or destruction of load(s) or conservation activity occurring on the customer’s distribution system, including fuel switching.
Retail Access Load Gain	The customer may purchase additional power at the appropriate PF rate with adjustments.
Retail Access Load Loss	See Continuing Payment Obligation section above. The customer may select the Remarketing product for retail access mitigation.
Associated Services	Depending on resource size, payment for Generation Management Services (GMS) may be required if the customer wishes to qualify the resource for measured amount netting treatment in the billing process. The amounts and types of GMS would be determined on a resource-specific basis. See the description of the GMS group of products and services in this catalog.
Interaction with other products	Since this product includes a component to meet load variations, it should not be combined with any other core product that allows variability to meet load shape. This product may not be purchased in combination with the Slice product, Actual Partial Service, Block With Factoring, or Block With Shaping Capacity.

Detailed Description: Actual Partial Service - Simple and Complex Versions

1. General & Availability:

These are core Subscription products that are available to purchasers who have a right to purchase from BPA for their requirements. These products are intended for customers who have contractual or generating resources with firm capabilities and therefore require a product other than Full Service. These products provide service to net actual load in a manner equitably comparable to the Full Service product. These standard core products will be sold under a posted rate schedule. Billing factors for these products are described in the Billing Factor Tables (see Appendix B).

2. Simple and Complex Versions:

The Simple and Complex versions of this product category differ in that the Complex version only is subject to the Factoring Benchmark tests in the billing process. The Factoring Benchmark tests will be applied to the billing data of a Complex Actual Partial Service purchaser because that customer's resource declared amounts are able to be dispatched and shaped in a manner which increases BPA's costs to serve.

The Simple version of Actual Partial Service encompasses several approaches to customer resource declaration, all of which obviate the need for the Factoring Benchmark tests. To choose the Simple version of Actual Partial Service, a customer declares its resource amounts in one of two ways. First, the customer could declare fixed resource hourly amounts which, depending on the resource characteristics, could be flat, i.e., equal for all hours, or shaped among hours per BPA/customer mutual agreement. Second, the customer could declare the full output of its resources for service to its system load as "Dedicated Resources". Principles for the Dedicated Resources version of Simple Actual Partial are included at the end of this section.

3. Timing and Duration of Purchase Commitment:

To purchase these products at unadjusted posted rates, the purchaser must establish its declared resource amounts for all periods of the purchase commitment, except where otherwise specified in the Customer Resource Portfolio Declaration Parameters below. Resource declarations must be made at the time of commitment, and in any case, not later than the end of BPA's Subscription process. The term 'periods' refers to the HLH & LLH periods of rate seasons, e.g., calendar months and years.

4. Product Description:

a. Customer Resource Portfolio Declaration Parameters

Customer resource portfolio declared amounts will be set at the time of contract signature for the duration of the commitment, consistent with the following:

- 1) Customer resource portfolio amounts will be declared in HLH and LLH energy amounts and demand amounts for each month of the term of commitment.
- 2) These core products are available to serve net requirements under section 5b1 of the NW Regional Act. Therefore, the monthly HLH/LLH resource portfolio amounts to be declared will be the reasonably determined capabilities of the customer's firm peaking and energy resources as referred to in sections 5b1A and B of the Regional Act. The declarations will be consistent with BPA's policy on determining net requirements. Customers will notify BPA when required by that policy of load or resource changes that may affect the determination of net requirement. Initial declarations of customer resource amounts (for at least the term of the commitment) will include monthly peak and HLH /LLH energy amounts. The declared amounts will be based on reasonable and prudent utility practices and will be consistent with resource data used by the customer historically for purposes of its BPA contracts and for other purposes. Customer declared amounts may take into account change of condition reasonably affecting resource capability. Prudent utility practices for establishing firm hydro resource capabilities may include criteria other than critical period planning.
- 3) 5b1A and B coordinated hydro resource capabilities may be revised annually consistent with coordinated planning processes if the customer has chosen to declare the resource capability per Pacific Northwest Coordination Agreement (PNCA) critical period planning criteria.
- 4) If the customer acquires new renewable resources for which it wishes to declare a firm capability, such capability may be added within the term of commitment with as much advance notice to BPA as is practicable. Renewable resource firm capability would reflect the distribution among months of a year that is reasonable given its operating characteristics.
- 5) Declared resource portfolio amounts reflecting 5b1A or B generating resources and long term contracts which were declared prior to 2001, would be subject to the same principles as 1, 2 and 3 above.
- 6) Customer new resource amounts that are not related to resources referred to subsections 3, 4, or 5 above would be assumed for purposes of the standard core product to be distributed across years, months, and monthly HLH and LLH periods either: (i) flat, i.e., in equal amounts for all such periods, or (ii) proportionally based on shape of the purchaser's system load.
- 7) Customer declared resource annual amounts may increase over the years of the commitment term.
- 8) In operations, the customer may provide its declared resource portfolio amounts from available power sources, consistent with prevailing electric utility interchange and transmission scheduling practices. For purposes of this product, the sources of such power are not limited to specific 5(b)(1)(A) or (B) generation resources owned by the customer or specific contracts.
- 9) For purposes of assuring consistency with BPA's policy on determining net requirements, the customer will also provide data for resources which are not being declared for purposes of entitlement to this or other core Subscription products. The peak and

monthly HLH and LLH capabilities of such resources will also be based on reasonable and prudent utility practices and will be consistent with resource data used by the customer historically for purposes of its BPA contracts and for other purposes.

b. Transmission Delivery and Ancillary Services for the Product.

Network transmission delivery and ancillary services are not included. The amounts of product sold and billed for will be measured at Points of Metering (POMs) on the customer's system which often correspond to transmission Points of Delivery (PODs). BPA's Power Business Line will make power available at such point(s) of interconnection as are consistent with the prevailing transmission tariff solely for the purpose of delivery to the customer's system. For customers within the BPA control area, the product serves actual hour by hour entitlement as measured after the fact or served by General Transfer Agreement. This product therefore includes the non-ancillary power service of dynamic "load following".

c. Transmission and Ancillary Services for Non-Federal Resources.

Customer or consumer generation is assumed to have all transmission, ancillary services such as energy imbalance service and any miscellaneous shaping or support services provided by separate arrangement.

5. Customer Resource Operational Flexibility

The product imposes no direct contractual constraint on customer resource management. Customer resource operation choices would have billing impacts in event that they resulted in underruns or overruns under this product.

6. Scheduling Practices

a. Customers inside BPA Control Area (CA). Amounts of Actual Partial Service product will not be scheduled by customers within the BPA CA, unless otherwise specified in the contract. Customers within the BPA CA will schedule their declared resource amounts in accordance with prevailing interchange scheduling practices, unless otherwise specified in the contract. Customers will provide hourly schedules for all resource deliveries and hourly net transfers for their systems. Hourly net transfer will be separately accounted for as follows:

- (1) Net transfer into customer system from point within the BPA CA,
- (2) Net transfer from customer system to point within the BPA CA,
- (3) Net transfer into customer system from point outside the BPA CA,
- (4) Net transfer from customer system to point outside the BPA CA,

Customers may make changes from prescheduled resource amounts by notice not later than 30 minutes prior to the hour.

b. Customers outside BPA CA.

For customers outside the BPA CA, the product will assume use of prevailing BPA interchange prescheduling practices. The product will be prescheduled only, unless otherwise specified by contract.

7. Complex Version Only -- Factoring Service and Benchmark for Customers Declaring Variable/Dispatchable Resources.

This product does not provide services to support, shape or absorb variability due to customer resource operation. Customers who do not make resource declarations as described above for the Simple version of Actual Partial Service may purchase the Complex version. For purchasers of the Complex version of Actual Partial Service, the Factoring Service Benchmark Methodology will be applied in the billing process. The customer will be subject to excess Factoring Service charges as described in the Factoring Service product description.

Detailed Description: Actual Partial Service with Dedicated Resource(s)

General & Availability:

This product is a core Subscription product that is available to customers with variable/dispatchable resources. The product is designed for customers who agree to dedicate the entire output of their resource(s), both firm and secondary, to serve their system load, and forgo trading in opportunity markets (except in the case of purchases to support assured capability as mentioned below). PF billing would be on the difference between the customer's actual load and its firm resource amounts. When the customer has delivered secondary energy to its load, the customer would receive a market-indexed-based dollar credit (a negotiated amount under BPA's FPS Rate Schedule) that would net against the PF payment for the entitlement amount. The methodology for this credit would be negotiated under the FPS Rate Schedule and would reflect a fair value of that secondary energy. The output of the resource(s) would be planned and dispatched by the customer in such a way as to provide the most economical operation possible to the customer while meeting BPA's business test of a cost of service no greater than that of a full service product.

Timing and Duration of Purchase Commitment:

Resource declarations would be made consistent with the declaration parameters of the Actual Partial Service product. Since this product is most likely to be of interest to parties with hydro resources, the customer would prepare an annual exhibit consistent with the PNCA Final Regulation (or other agreed methodology appropriate to the customer's resource), further breaking down monthly firm energy capability into HLH and LLH amounts.

Product Description:

The customer agrees to apply their entire resource output to serve their system load. The customer will plan, operate, and dispatch its resource output to the extent possible in such a manner as to provide the most economical purchase of PF to serve its customers.

The customer would prepare and submit an annual assured capability exhibit, consistent with the final regulation under the PNCA or other agreed upon methodology appropriate to the resource. The exhibit will specify peak capability and HLH and LLH energy capability by month. Since the customer would be declaring the assured capability of the resource(s), it would be obligated to support those resources in the event of resource under-performance.

Credit-Back For Delivery of Greater Than Assured Energy Capability.

In a billing month for which the PF amounts taken are less than the PF entitlement amounts, BPA will provide a billing-credit back to the customer to reflect delivery of excess energy, therefore resulting in unused entitlement energy. If the customer has purchased power in the billing month to support its Assured Capability, the amount of such purchase will be deducted

from the amount of excess energy prior to applying the credit-back. The value of the credit would be based on an agreed upon methodology under BPA's FPS Rate Schedule.

Power Scheduling, Accounting and Billing Data Provisions:

Customers outside the BPA CA. The customer will set the hourly amounts of this product at time of preschedule. The amounts scheduled will be deemed to have been delivered and will be used as PF amounts taken in the billing process. At month end, there will be an after-the-fact (ATF) determination of entitlement. The PF HLH and LLH energy entitlement would equal the difference between the ATF HLH and LLH energy loads and HLH and LLH assured energy declaration. The PF demand entitlement would equal the greater of: a) the average HLH monthly entitlement; or, b) the difference between the ATF coincidental system peak and declared peak capability.

The PF billing amounts will be the entitlement amounts whether or not they were taken. If the scheduled PF amounts exceed the entitlement, the customer will be subject to the Unauthorized Increase Charges in the posted rates.

Customer inside the BPA CA. For customers inside the BPA CA, amounts of this product will not be scheduled. Instead customer resource amounts will be scheduled (1) as interchange schedules if they are being delivered from outside the BPA CA, or (2) as informational best estimates, i.e., 'memo' schedules if the resource is within the customer's system. Interchange scheduled resource amounts may be changed up to 30 minutes prior to an hour for the purpose of better meeting the customer's load. Resources within the customer's system may be dispatched to meet its actual real-time load to the extent the customer has the ability to control them. Amounts taken of this product will be determined using after the fact measurements of customer hourly system load, interchange scheduled quantities where appropriate, and after the fact measurements of actual generation within the customer's system. Determination of entitlement would be the same as for a customer outside the BPA control area.

The PF billing amounts will be the entitlement amounts. If the net metered amounts taken by the customer from BPA exceed the entitlement, the customer will be subject to the Unauthorized Increase Charges in the posted rates.

BPA POWER PRODUCTS CATALOG

<i>Core Subscription Product</i>	<i>Factoring</i>
General	For purposes of the core Subscription products, the term “factoring” refers to the service of shaping a given quantity of MWhs among (With-in Day) hours of a day or (With-in Month) days of the month, to follow load. Factoring Service is distinct from that feature of the Full and Actual Partial Services which meets energy load variance. This service is a bundled component of Subscription Core Products for Full Service and Actual Partial Service. Factoring, subject to the benchmarking process, may be purchased as a staple-on to a Firm Block core product. Complete details are in the attached pages.
Availability	This product is intended for customers who have a right to purchase under NW Power Act, section 5(b) from BPA. Full Service customers are those who choose to purchase all of their power needs from BPA, including those who have small non-dispatchable generating resources.
Purchase Period	Factoring may be purchased for the same period as the underlying block purchase, beginning October 1, 2001 (or another term consistent with the Rate Schedules).
Transmission and Ancillary Services	Transmission delivery and Ancillary Services are not included in this product except as noted below. Any Energy Imbalance that occurs as a result of Retail Access Load Loss is not covered by this product.
Load Variance	Not included.
Load Growth	Not included.
Linkages	Factoring Service is available in conjunction with the purchase of core Block power products. This service is a bundled component of Subscription Core Products for Full Service and Actual Partial Service.
Applicable Rates and Billing Factors	See Core Product Billing Factors in the catalog, Appendix B. Refer to 2002 Proposed Wholesale Power Rate Schedule for applicable posted rates.
Transmission Losses	Transmission Losses are not included in this product.



Detailed Description: Factoring Service and Benchmark Methodology

General & Availability:

For purposes of the core Subscription products, the term “factoring” refers to the service of shaping a given quantity of MWhs among hours of a period to follow load. Factoring Service is distinct from that feature of the Full and Actual Partial Services which meets energy load variance. This service is a component of the Subscription core products for Full Service and Actual Partial Service. It is designed to provide a basis for giving access to load following service with equitable comparability for the broad spectrum of customers BPA is expected to serve. Factoring may also be purchased as a staple-on service to a core Block product.

Timing and Duration of Purchase Commitment:

The term of this service shall be coterminous with that of the core product purchased. When purchased as a staple on service to the Firm Block product however, the customer will have the option of adding the Factoring Service for all or a portion of the purchase period of the Firm Block product.

Product Description:

For purposes of the core Subscription products, the term factoring refers to the service of shaping a given quantity of MWhs among hours of a period to follow load. (The term ‘periods’ refers to the HLH & LLH periods of rate seasons, e.g., calendar months and years.) There are two types of Factoring: Within-Day, which measures the amount of energy moved within each diurnal period of a day and Within-Month, which measures the amount of energy moved between the days of each month. In this context, factoring is therefore an ‘energy-neutral’ service. Factoring Service is distinct from the Load Variance component of the Full and Actual Partial Service products. Load Variance meets the plus or minus uncertainty in cumulative monthly MWh load, such as the variance due to temperature-related power consumption, or changing electric load within a customer’s system (for reasons other than annexations, retail access choices, or service to New Large Single Loads).

When purchased as a staple-on service to a core Block product, the Factoring Service remains energy-neutral. Block with Factoring offers the purchaser access to a posted rate service for shaping Block energy to its actual load to the extent of Block energy purchased. It does not increase or decrease the amount of Block billing energy or the amounts the customer is entitled to receive at the posted price. When purchased as a staple-on service to a core Block product, monthly resource capability must be declared for the purchase period consistent with the resource declaration parameters in the detailed description for the Actual Partial Service product. A Block customer with declared dispatchable resources would be subject to the same billing and excess service charges as an Actual Partial customer with dispatchable resources.

Transmission Delivery and Ancillary Services for the Product:

Per the provisions applicable to the underlying core product.

Scheduling Provisions:

When outside BPA's control area the customer will submit preschedules in accordance with BPA power scheduling procedures, unless otherwise mutually agreed.

Factoring Service within the Benchmark:

By definition, customers without resources or customers whose resources are delivered flat will take and receive exactly the amount of Factoring Service that they are entitled to take. This amount is called the Factoring Benchmark. Only when customer resources have hour-to-hour dispatchability is there a possibility of receiving Factoring Service amounts which are less or greater than the entitlement amount. There are no additional charges for Factoring Service which is within the benchmark. Factoring Service does not provide back-up or other services for customer resource amounts which are interrupted or otherwise fail to be delivered. For example, if a customer within the BPA control area were a Simple Actual Partial purchaser and had only a flat fixed resource, they would not be subjected to Factoring. Therefore, if the flat resource fails to be delivered for some reason, the default BPA service provided is either "unauthorized increase" or a negotiated back-up service, not Factoring Service.

Billing Process:

Determination of Factoring Service Actual Use – Billing Determinants for Excess Charges

With-in Day factoring: For each hour of a day, the day's after-the-fact HLH and LLH Total Retail Load (TRL) will be compared to the shape of the customers actual resource deliveries for each corresponding HLH and LLH period. Differences between the two shapes will be used to calculate the amount of Factoring Service used (if any) in kWhs for each period. The Customer's actual use of this service will be compared against a Factoring benchmark. The benchmark is intended to define the total amount of energy BPA should expect to move between hours of a period to cover the differences between a customers TRL and the hour-to-hour output capability of their resources. Any Factoring Service used in excess of the benchmark, will be added to that days billing determinants. Excess Factoring amounts shall be measured in kWhs for each period. The methodology for calculating the Excess Factoring Service charge will be posted with other rates for the core products. Amounts of Factoring Service used which are less than the benchmark entitlement amount will not be taken into account.

The graphs below are intended to give a basic graphical overview of how the Within-Day Factoring Service will be applied and calculated. They are not intended to cover how the billing determinates are applied, but rather are intended to just communicate the concept of factoring and how it will be applied to customers.

Within-Day (daily, between hrs) Factoring

Graph 1 - Establishing the base Factoring Amount

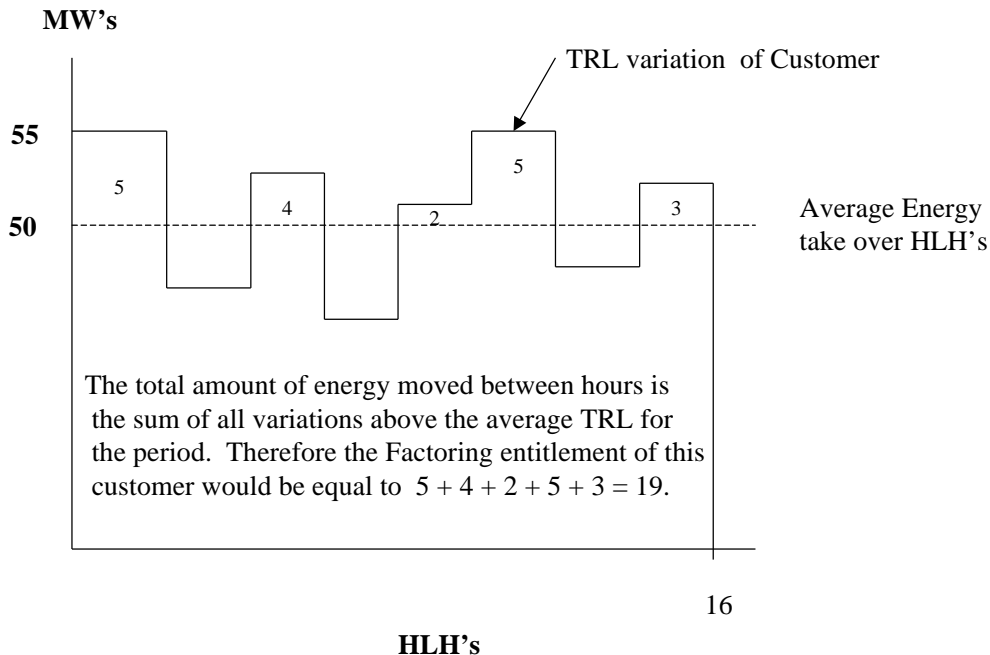

Within-Day (daily, between hrs) Factoring

Graph 2- Flat Customer Resource

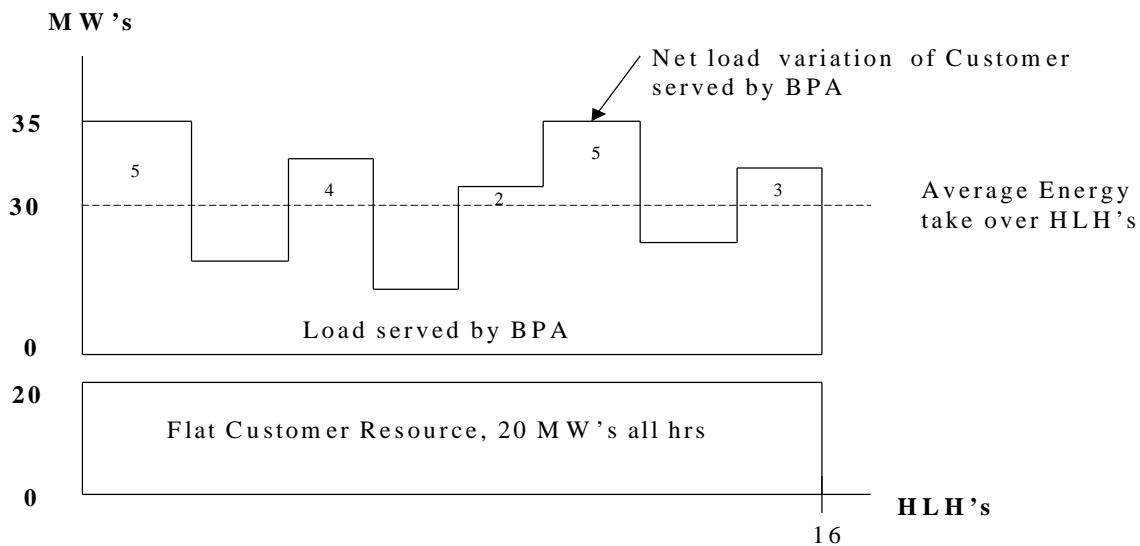

Since the customer Resource is flat, the hr to hr load variation which BPA serves remains unchanged, hence no excess Factoring charge shall apply in this example. Numerically, this load served above the average equals 19 units. $(5+4+2+5+3)$



Within-Day (daily, between hrs) Factoring

Graph 3 - Customer Resource which increases load variations

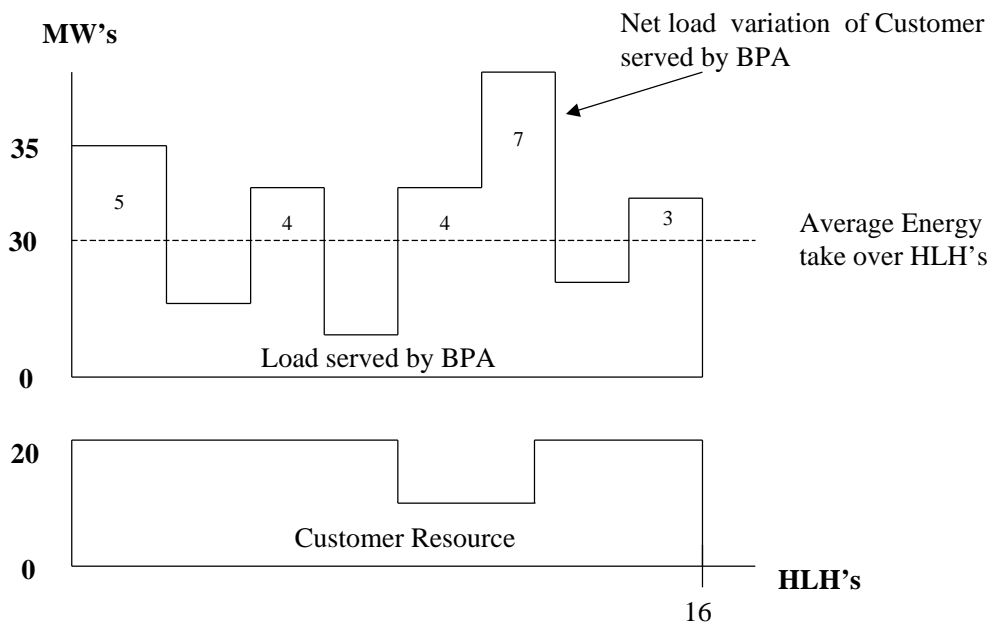

Since the customer Resource as operated adds to the hr to hr load variation which BPA serves an excess Factoring charge shall apply to cover the additional energy BPA is required to move between hours. Numerically, $5+4+4+7+3=23$ which is greater than the customers entitlement of 19.



Within-Day (daily, between hrs) Factoring

Graph 4 - Customer Resource which decreases load variations

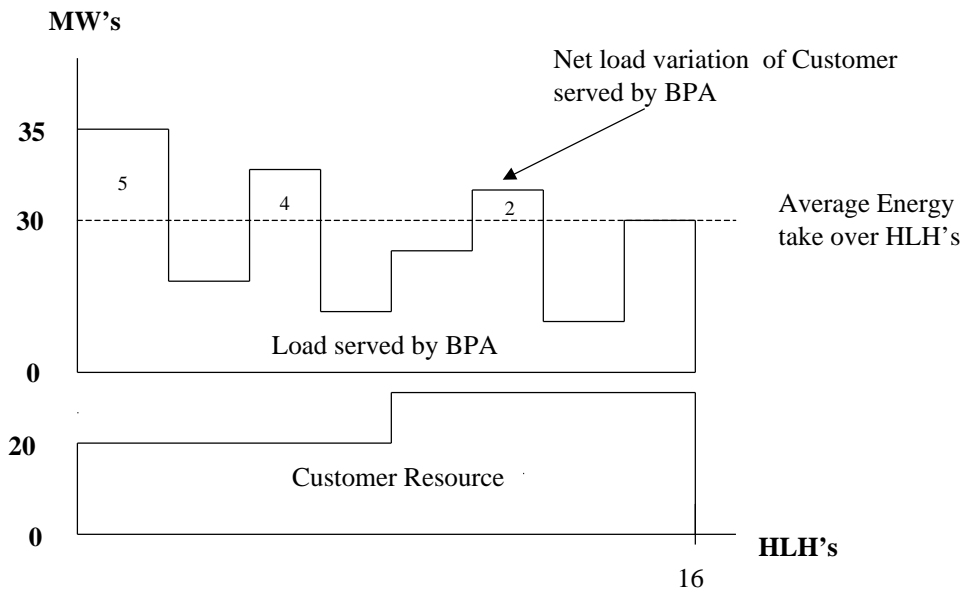

Since the customer Resource as operated decreases the hr to hr load variation which BPA serves, no excess Factoring charge will be required. Numerically, $5+4+2=11$ which is less than the customers entitlement of 19. Therefore no additional factoring charge shall apply.

With-in Month factoring: For each day of a billing month, the day's HLH and LLH TRL, actual customer resource deliveries and the daily Computed Average Energy Requirement (CAER) will be used to calculate that day's amount of kWhs entitled to benchmark Factoring Service. Actual customer use of the service will be compared to the benchmark. Actual Factoring Service used in excess of the benchmark amount or Factoring Service used which is less than the benchmark amount, whichever is greater, will be added for that months billing determinants for the excess Factoring Service charge. Such amounts shall be measured in kWhs. The excess Factoring Service charge methodology shall be posted with other rates for the core products. The graphs below are intended to give a basic graphical overview of how Within-Month Factoring Service will be applied and calculated.

Within-Month (Monthly between Days) Factoring - HLH Example*

Graph 1 - Establishing Upper and Lower Boundaries

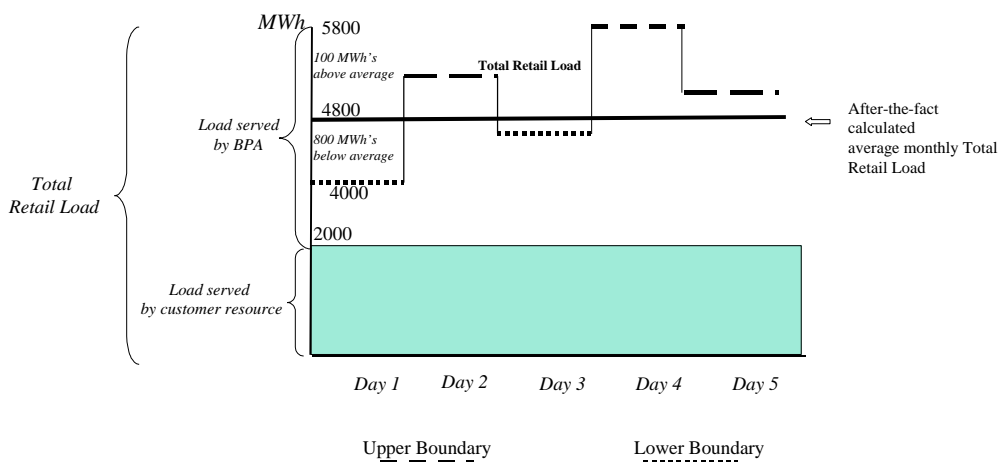

Allowable within month factoring service is based on the utilities' load.
 * This example is for HLH's. There is the same test for LLH's, taking into consideration the number of LLH's in each day of the month.

Within-Month (Monthly between Days) Factoring - HLH Example

Graph 2 - BPA provides energy to the customer between flat and the customers' load shape

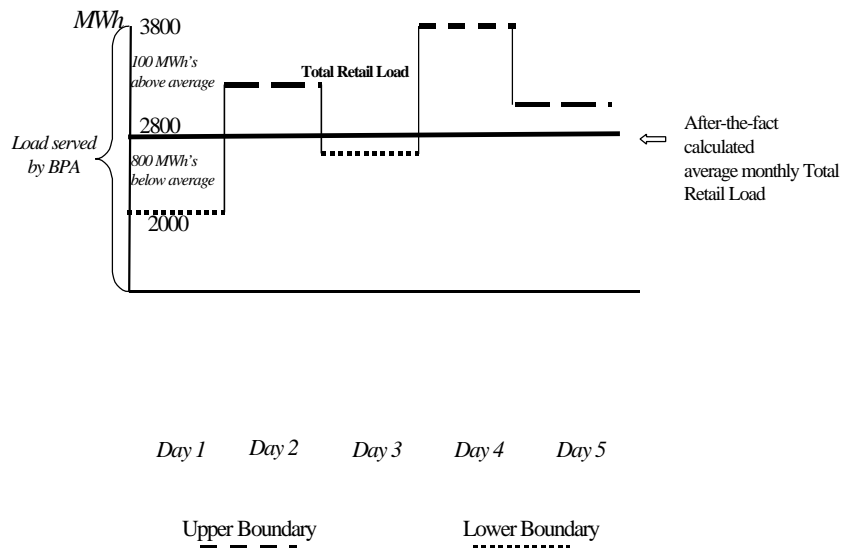

Within-Month (Monthly between Days) Factoring - HLH Example

Graph 3 - Excess Charge for Operating Resource in a Different Shape than Total Retail Load

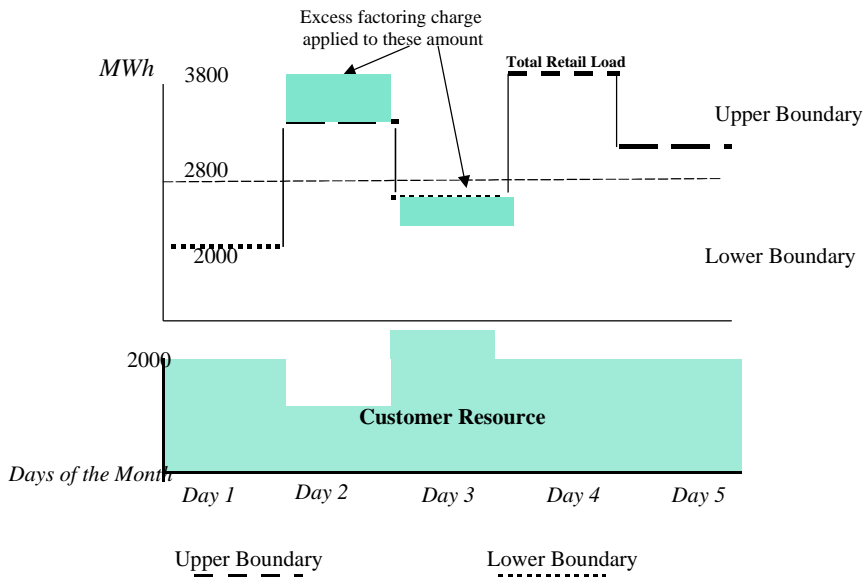

The factoring test identifies if the day by day shape of the customer's take from BPA used more within month factoring service than the underlying load would have used. In this example, the BPA take is altered to reflect changes in the operation of the customer resource and falls outside the established boundaries. Excess factoring charges are applied to either the area above the upper boundary or the area falling below the lower boundary, whichever is greater.

Within-Month (Monthly between Days) Factoring - HLH Example

Graph 4 - No excess Charge for Operating Resource in a Shape Consistent with Total Retail Load

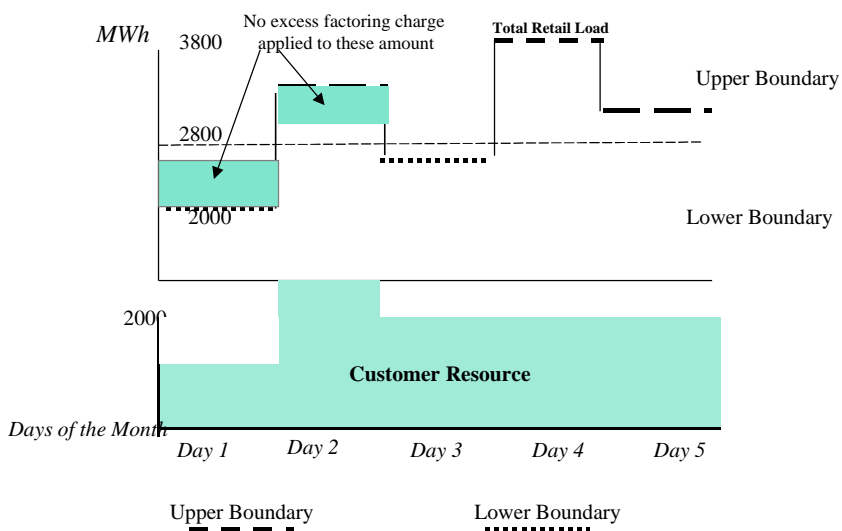

In this example, the BPA take is again altered to reflect changes in the operation of the customer resource but falls inside the established boundaries. Excess factoring charges are not applied.



BPA POWER PRODUCTS CATALOG

<i>Core Subscription Product</i>	<i>Block Partial Service</i>
General	<p>The Block Partial Service standard product is a core Subscription product. It is available to purchasers who have a right to purchase power from BPA to meet their net requirements.</p> <p>The purchase amounts for all HLH and LLH periods for the term are set at the time of contract signature.</p> <p>Complete details are in the attached pages.</p>
Availability	This product is intended for customers who have a right to purchase from BPA under section 5(b) of the Regional Act.
Purchase Period	The purchase period is 3 to 20 years, beginning October 1, 2001.
Transmission and Ancillary Services	Transmission delivery and ancillary services are not included in this product.
Load Variance	Not included.
Load Growth	HLH and LLH block amounts may increase over the term of commitment based on the customer's net requirement.
Linkages	<p>The Block Partial Service product may be combined with one of the following:</p> <ul style="list-style-type: none"> • Factoring Service • Shaping Capacity • Slice* <p>** See Slice product description for details on allowable combinations of Block and Slice.</p>
Rates and Billing Factors	See Core Product Billing Factors in the catalog, Appendix B. Refer to BPA's 2002 Proposed Wholesale Power Rate Schedule for applicable posted rates.
Transmission Losses	Transmission Losses are not included in this product.



Detailed Description: Block Partial Service

General and Availability:

This standard product is a core Subscription product that is available to purchasers who have a right to purchase their requirements from BPA. This standard product will be sold under a posted rate schedule.

Timing and Duration of Purchase Commitment:

To purchase this standard product at unadjusted posted rates, the purchaser agrees to its purchase amounts for all HLH and LLH periods during the term of commitment at the time of contract signature, and in any case, not later than the closing date for BPA's Subscription process. The term 'periods' refers to the HLH and LLH periods of calendar months and years.

Product Description:

Purchase Amounts:

1. This core product is available to serve net requirements under section 5b1 of Regional Act. Therefore, the HLH and LLH period purchase amounts that may be subscribed to per year and month may not exceed the reasonably estimated differences between the customer's load and the capabilities of the customer's firm peaking and energy resources for each of the years of commitment. The resource capabilities for the years of the term of commitment will reflect, to the extent appropriate, permanent loss of resource consistent with BPA's published policy on determining net requirements. The resource capabilities will be determined consistent with the Resource Declaration Parameters listed under the Actual Partial Service Product. The section below, "HLH and LLH Block Distribution among Years and Months" highlights the options available under the Block Product.
2. During the term of commitment, the customer will give BPA notice of load changes that may reduce its net requirement, consistent with the procedures specified in BPA's published policy on Determining Net Requirements. If such notice shows that the customer's net requirement has decreased, the remaining Block purchase amounts will be reduced accordingly. Billing for the block purchase amounts will be adjusted based on the terms of the customer's contract and any mitigation measures purchased.
3. Customers may elect to purchase an amount which is less than the maximum indicated under point 1 above. However, the standard product requires that such amount be expressed as a percent reduction, with the same percentage applied to all years, months and diurnal periods of the purchase commitment period. Reductions would not be targeted to only certain years, months or diurnal periods.

4. Customers that wish to purchase more than their net requirement may negotiate such additional purchase amounts with BPA subject to availability and under the then-applicable FPS rate schedule.

HLH and LLH Block Distribution Among Years and Months:

Provisions for allowable distribution of Block purchase energy within the purchase commitment term are described below. Other distributions may be mutually agreed upon, provided that BPA will have the right to a price adjustment under the FPS rate schedule in the event such alternative distribution would have a significantly different business impact on BPA's cost to serve.

1. Under the Block standard product, hour by hour MW amounts will be the same for all LLHs or HLHs of a calendar month.
2. The annual amounts may be distributed among years as follows:
 - a. Increasing over the years of commitment, as long as consistent with the principle in point 1 under "Purchase Amounts".
 - b. Equal for each year of commitment. The block amount is based on the customer's net requirement for the first year of commitment.
 - c. Decreasing over the years of commitment, as long as not inconsistent with the principle in point 3 above under "Purchase Amounts".
3. The HLH and LLH period monthly amounts of the product may be distributed as follows:
 - a. Equal for all months of a year.
 - b. Proportional to the monthly distribution of the customer's estimated system load or in the case of a net requirement, proportional to the distribution of the customer's load net of 5b1A and B resources.
4. All or a portion of the customer's maximum HLH purchase amount (consistent with point 1 under "Purchase Amounts") may be declared as a Block purchase for LLHs only, or with greater LLH amounts than HLH amounts.
5. Block maximum declared HLH purchase amounts must be consistent with the diurnal distribution of purchaser's net requirement (see point 1 under "Purchase Amounts").
6. The Block Partial Service product may be combined with the Actual Partial Service product. See the description of the Actual Partial Service product for more details.

7. Factoring service, subject to bench marking in the same manner as applicable to an Actual Partial Service customer with dispatchable resources, may be purchased as a core product staple-on. See the description of factoring service and benchmark methodology for more details.
8. Shaping capacity may be purchased as a core product staple-on to the Block product. See the description of Block with Shaping Capacity for more details.
9. The Block Partial Service product may be combined with Slice only as specified in the Slice product description. For the Block product, the limits on customer distribution of the HLH and LLH period block amounts, among years and months, will be based on the shape of the customer's net requirement prior to considering Slice.

Transmission Delivery and Ancillary Services for the Product.

Transmission delivery and ancillary services are not included.

Scheduling Provisions

The customer will submit preschedules in accordance with BPA power scheduling procedures, unless otherwise mutually agreed.

<i>Core Subscription Product</i>	<i>Block With Shaping Capacity</i>
General	Shaping Capacity is a core Subscription product available only to purchasers of Block Partial Service. It applies to HLH block purchases only. The product is prescheduled and energy neutral within each HLH period. Shaping Capacity amounts will be set at the time of contract signing. Complete details are in the detailed description.
Availability	This product is intended for customers who have a right to purchase from BPA under section 5(b) of the Regional Act.
Purchase Period	Shaping Capacity may be purchased for any period that a HLH block is purchased during the contract term., beginning October 1, 2001 (or another term consistent with the Rate Schedules).
Transmission and Ancillary Services	Transmission delivery and ancillary services are not included in this product.
Load Variance	Not included.
Load Growth	Not included.
Linkages	Shaping Capacity is available at a posted rate for Block Partial Service, for HLH blocks only.
Rates and Billing Factors	See Core Product Billing Factors in Appendix B of this catalog. Refer to BPA's 2002 Proposed Wholesale Power Rate Schedule for applicable posted rates.
Transmission Losses	Transmission Losses are not included in this product.

Detailed Description: Block Partial Service With Shaping Capacity

General and Availability

Shaping Capacity is a core Subscription product available only to purchasers of Block Partial service for HLH blocks. This standard product is sold under a posted rate schedule. If a customer's HLH net energy requirement exceeds its net peak requirement, Block With Shaping Capacity may not be purchased at posted rates.

Timing and Duration of Purchase Commitment

To purchase this standard product at unadjusted posted rates, the purchaser must fix the desired purchase amounts of Shaping Capacity for all HLH block purchase periods of the term of commitment prior to contract signing, not later than the closing date for BPA's Subscription process. Shaping Capacity may be selected by the customer for the HLH periods of less than all months of a year. The term 'periods' refers to the HLH periods of rate seasons, e.g., calendar months and years.

Product Description

Block with Shaping Capacity allows a customer a predetermined monthly MW amount above and below the flat HLH Block to shape the energy. It is pre-scheduled, and energy neutral within each HLH period.

Monthly demand limits are determined before contract signing. The customer declares the monthly demand levels for each month and year of the contract term subject to those limits.

The use of Shaping Capacity is energy neutral within each day. For the HLH period of a day, the sum of the differences between each hour's schedule and the HLH Block aMW amount must be zero.

The lower MW boundary is equal to the amount of Shaping Capacity purchased above the flat block.

This product is prescheduled only. Prescheduling will be consistent with BPA's power scheduling procedures.

Block With Shaping Capacity is not subject to factoring checks against total system load.

Because the PF demand charge is only applicable to billing demands set during HLH, the Shaping Capacity product availability is limited to shaping HLH block energy. Consistent with the definition of BPA Rate HLH, the product is usable within HLH, Monday through Saturday.

LLH shaping capacity is available through bilateral negotiation under the FPS rate schedule. Customers may negotiate such additional purchase amounts with BPA, subject to availability and under the then-applicable FPS rate schedule.

This product may not be combined with Actual Partial Service or Slice.

The customer is billed for contract amounts of energy and demand.

Maximum Purchase Amounts

The maximum purchase amount for this product is subject to two tests:

1. Is the customer's HLH net peak requirement greater than their HLH net energy requirement? If no, then this product may not be purchased at posted rates. If yes, continue to second test. This net peak requirement amount sets the first limit on the block with shaping capacity entitlement.
2. Calculate an amount which reflects the customer's reasonably expected monthly HLH system load factor. This limit is the amount which, when added to the monthly HLH block MW, results in a product capacity factor not less than the customer's monthly HLH system load factor.

The customer's block purchase amount is determined using the method described in the "Block Partial Service" product description. The customer's entitlement to additional capacity for HLH blocks is calculated by dividing the HLH block by the customer's HLH load factor for each month of the contract term subject to the limiting amount in the first test.

Example:

1. Determine the months for which the customer has a net peak requirement that exceeds its over the life of the contract.
2. Calculate customer's system HLH load factor for each of those months:
$$\frac{\text{Average HLH Monthly Energy}}{\text{HLH Monthly Maximum MW}} = \text{HLH Load Factor \%}$$
$$\frac{27 \text{ aMW}}{36 \text{ MW}} = 75\%$$
3. Divide the HLH block purchase by the HLH system load factor:
$$\frac{20 \text{ MW Block}}{75\% \text{ HLH Load Factor}} = 26.67 \text{ Block With Capacity}$$
4. Round up to nearest whole MW: 27 MW
5. A customer may purchase 1 to 7 MW of additional capacity to be added to the 20 MW block purchase for the example month.

Customers wishing to purchase more than the maximum amounts may negotiate such additional purchase amounts with BPA, subject to availability and under the then-applicable FPS rate schedule.

- The customer may elect to purchase less than its maximum entitlement to additional capacity for HLH blocks. In the above example, since the customer is entitled to 1 MW to 7 MW of additional capacity, it could elect to purchase only 5 MW.

Graph 1 - Example of 20 MW Block With 5 MW Shaping Capacity

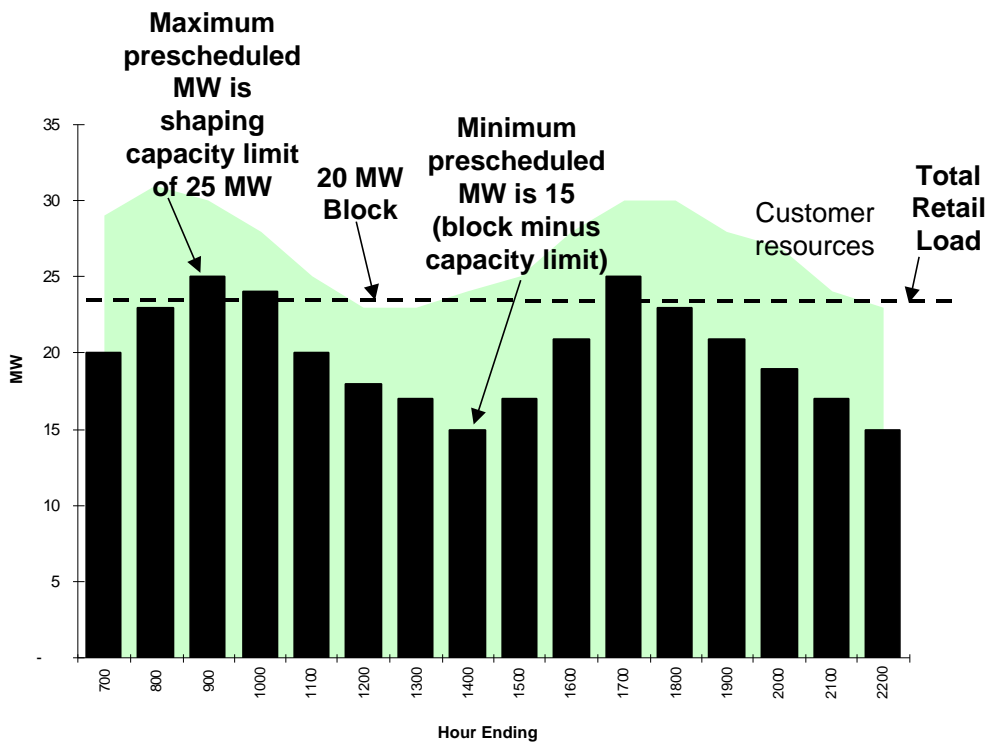

	700	800	900	1000	1100	1200	1300	1400	1500	1600	1700	1800	1900	2000	2100	2200	Total MWh
Block Purchase	20	20	20	20	20	20	20	20	20	20	20	20	20	20	20	20	320
Prescheduled Block Plus Shaping Capacity	20	23	25	24	20	18	17	15	17	21	25	23	21	19	17	15	320

Scheduling Provisions

The customer will submit preschedules in accordance with BPA power scheduling procedures.



<i>Core Subscription Product</i>	<i>Block with Factoring</i>
General	<p>Factoring is a core Subscription product available to purchasers of Block Partial Service. When purchased with a Block product, the Factoring service provides some shaping of the fixed Block energy amounts to customer actual load. The Factoring service does not change the amounts of Block energy which the customer has a right to receive or for which it must pay.</p> <p>When purchased with a Block product, the Factoring service requires declaration of resources. As with Actual Partial Service, there may therefore be ‘simple’ versus ‘complex’ purchasing situations depending on customer declared resource types. If the Block customer’s declared resource amounts are variable such that they would have been subject to the Complex version of Actual Partial, the Factoring Benchmark procedures will be applicable. If the customer’s declared resource amounts are fixed in advance, Block With Factoring would not require the Factoring Benchmark procedures.</p> <p>See the description of the Factoring Service and Benchmark Methodology for details.</p>
Availability	<p>This product is intended for customers who have a right to purchase under NW Regional Act, section 5(b) from BPA.</p>
Purchase Period	<p>Block With Factoring may be purchased for any period that a Block is purchased, beginning October 1, 2001 (or another term consistent with the Rate Schedules).</p>
Transmission and Ancillary Services	<p>Transmission and Ancillary Services are not included in this product.</p>

BPA POWER PRODUCTS CATALOG

<i>Core Subscription Product</i>	<i>Block with Factoring</i>
Load Variance	Not included.
Load Growth	Not included.
Linkages	Block With Factoring is available at the posted rate for demand. See the description of core product billing factors attached to this catalog.
Rates and Billing Factor(s)	See Core Product Billing Factors in the catalog, Attachment A. Refer to BPA's 2002 Proposed Wholesale Power Rate Schedule for applicable posted rates.
Transmission Losses	If the purchaser is within the BPA control area and it's measured demand is determined from measurements at purchaser system points of metering, Network Transmission Losses will be taken into account for purposes of determining the billing demand.

CUSTOMIZED SUBSCRIPTION PRODUCTS

<i>Customized Product</i>	<i>Variable Load Factor</i>
General	The Variable Load Factor product provides the purchaser with a specified amount of capacity and the right to take energy within a specified load factor range.
Purchase Period	The purchase period is 3 to 20 years, beginning October 1, 2001 (or another term consistent with the Rate Schedules).
Transmission and Ancillary Services	Transmission and Ancillary Services are not included in this product.
Amount and Shape	This is available up to a negotiated monthly capacity amount. The customer can specify a monthly load factor range that will be reflected in the pricing. Capacity and minimum load factor are “take-or-pay.”
Load Growth	None; the amount is fixed.
Load Variations	BPA assumes the risk of all variations in power consumption within the limits of the specified capacity and load factor.
Resource Fluctuations	This product is intended to follow load variations only. The customer retains the risk of resource fluctuations.
Linkages	None.
Basis for Payment	Payment is based on contract demand and amount of energy used (but not less than take-or-pay amount).

<i>Customized Product</i>	<i>Slice of the System</i>
General	<p>The Slice of the System product is available to PNW public preference purchasers that have a NW Regional Act Section 5(b)(1) regional net firm requirements load. This product provides firm power, based a calculated percentage share of the capability of specified Federal System Resources, including actual energy generation (firm and secondary) and storage capability. This product is provided by schedule. If requested by the purchaser, BPA will work with the purchaser to explore ways to provide the product by dynamic scheduling.</p> <p>A more detailed description of this product is attached.</p>
Purchase Period	The purchase period is 10 to 20 years with no off-ramps, beginning October 1, 2001.
Transmission and Ancillary Services	Transmission and Ancillary Services are not included with this product.
Amount & Shape	At the beginning of the contract, BPA and the purchaser will establish the firm resources and the net firm requirements load of the purchaser on an average annual megawatt basis for the first year of the contract, consistent with methodologies used to determine firm net requirements load for purchasers of the Block Partial Service product. Actual power received will vary, depending on the power output of the Federal System Resources.
Load Growth	None.
Load Variations	None.
Resource Fluctuations	This product does not guarantee that purchaser load will be met on any hour, due to the fact that the sale is indexed to the generation from the Federal System Resources.

BPA POWER PRODUCTS CATALOG

<i>Customized Product</i>	<i>Slice of the System</i>
Linkages	This product cannot be purchased in combination with Full Service or Actual Partial Products. This product can be purchased with the Block Partial Service Product <i>at a 100% load factor each month and</i> no Factoring, Capacity, or other staple-on option.
Basis for Payment	The cost of a Slice is based on a percentage share of a contractually determined annual revenue requirement, including a true-up mechanism.

SLICE OF THE SYSTEM PRODUCT

General

- This product is a bundled requirements and surplus power sale.
- This product includes the right to receive power indexed to the generation from certain specified Federal System Resources (System Resources).
- This product includes the right to modify the rate of delivery within the day, week, month, and year, based on indices that are tied to the then-existing minimum and maximum capabilities of the System Resources, after considering non-power requirements.
- BPA may withhold the requirements portion of Slice that is in excess of the customer's net firm requirements load, on an annual planning basis, to the extent necessary to assure service to BPA's other statutory or contractual commitments in the PNW.
- This product includes an obligation to pay a percentage share of BPA's revenue requirements without credit for secondary sales.
- The purchaser will assume the performance risks for its share of the Federal System Resources.
- BPA will be released from any BPA obligation to serve purchaser's load that is not met by the combination of Slice, other firm purchases from BPA, and the purchaser's own resources.
- A set-up and testing period is required before 10/1/01 in order to test the implementation of Slice.

Term

- The term is 10 to 20 years.
- There are no off-ramps.
- A Slice purchase will not affect purchaser's rights to purchase BPA power after the Slice contract terminates.

Eligibility to Purchase

- All Subscribers will be PNW Public Preference purchasers that have a NW Regional Act Section 5(b)(1) regional net firm requirements load.
- The firm portion of Slice sold in Subscription would be used to serve net firm requirements load (total retail firm load minus customer declared resources).
- Slice contracts will establish a percentage amount for the contract term **based on** the net firm requirements load. The net firm requirements load will be determined in the same manner as the Block Partial Service product.
- Net requirements rights would be mapped to Federal System firm resource capability, yielding a Slice percentage. Firm portions of Slice would count against net

requirements eligibility.

- Slice will not be available after the Subscription window closes.
- Slice percentages will not be adjusted for load growth (no remapping).
- Slice percentages will not be adjusted for decreases in Federal System firm resource capability (no remapping).
- Potential Slice purchasers will be required to pay set-up and implementation costs of the Slice.

Product Received

- The Slice entitlement is calculated using an index based on the output of System Resources, including both firm and secondary energy.
- The maximum and minimum rates of delivery are based on a proportionate share of the flexibilities of the System Resources between the minimum and maximum operating requirements. Slice purchasers would be kept informed of the minimum and maximum operating requirements by BPA.
- Slice energy will be scheduled via traditional prescheduling procedures. The possibility of receiving Slice by dynamic scheduling will be considered by BPA.
- The product allows the customer to vary energy delivered during a day, or between days, weeks, or months within the minimum and maximum operating constraints.
- Deviations of actual take from purchaser's right to generation based on the actual operation of the Federal System.
- The storage account will be zeroed out when System Resources reach points when the maximum and the minimum bounds of the storage account are identical (storage is non-guaranteed).
- Hour-ahead changes in the amount to be taken will be permitted (preschedule change rights).
- BPA will be relieved of its obligation to serve a Slice purchaser's net firm requirements load.
- There will be no protection against required spill.

Linkages

- The only core Subscription product with which the Slice product can be combined is the Block Partial Service product. The Factoring, Capacity, or other staple-on products will not be available. The Block Partial Service product may be combined with Slice only if the annual Block amounts do not increase over the term of the commitment based on the customer's net requirements and have a 100% load factor for each month.

Costs to Purchasers

- Slice purchasers will pay a corresponding percentage of BPA's PBL revenue requirement without adjustment for secondary revenue credits, and which excludes:

1. Costs of transmitting Slice power to the purchaser (other than those associated with the fulfillment of System Obligations);
 2. Power purchase costs (with the exception of those net costs incurred as part of the Inventory Solution); and
 3. Net Revenues for Risk.
- Responsibilities of the Slice purchasers will include their percentage share of all remaining PBL line item revenue requirements including, but not limited to:
 1. Generation integration;
 2. Treasury and WPPSS bonds;
 3. Residential/small farm exchange costs if they are a continuing Federal system obligation;
 4. All personnel and overhead costs for the PBL, including marketing, ratemaking, billing, and contract administration;
 5. General Transfer Agreement costs;
 6. Service and Exchange agreements;
 7. Costs of transmission of Canadian Entitlement return and the costs of transmission to support other Federal system obligations such as operational agreements;
 8. Net costs of relieving the expected FCRPS inventory constraint resulting from Subscription, including resource acquisitions and short-term purchases, if necessary, but not including future inventory constraints such as those from load growth;
 9. Environmental investments (some conservation and renewable resource costs);
 10. Other public purposes;
 11. Stranded costs (same treatment as other Subscription purchasers);
 - Slice purchasers will pay all costs of implementing Slice, including set-up costs.
 - Slice purchasers will have no direct influence or control over budget, investment, cost allocations, and marketing decisions. Those actions would continue to be taken per normal BPA practice.

Risks and Cost Shifts

- Slice purchasers assume a proportionate share of the risks of the FCRPS.
- Slice is designed to produce no cost shifts between Slice purchasers and other BPA customers.

Basis for Payment

- The cost of a Slice share is based on a percentage share of a contractually determined revenue requirement.

- Slice purchasers are responsible for their proportionate share of BPA’s actual costs. There will be true-ups to reflect actual BPA cost overruns or underruns, or extraordinary costs of generating units (“acts of God”).
- There will be no credits from BPA’s marketing revenues.

Resources Included/Excluded

- Included are Federal System hydro and thermal resources committed prior to the 1998-99 Operating Year (less Canadian Entitlement, Hourly Coordination, PNCA, Non-Treaty Storage, Biological Opinion, and TBL obligations).
- Included are public purpose resource acquisitions.
- Excluded are resources acquired for specific customers under other agreements.
- Excluded are short-term purchases.

Transmission

- Transmission is not included. The purchaser obtains its own transmission for delivery of Slice to its system.

Generation Reserves

- The customer is responsible for generation reserves to meet reliability standards.

Scheduling and Accounting

- Use of storage is accounted for daily in a “storage account.”
- Scheduling and accounting provisions will be established by contract.
- BPA may adjust the rate of power deliveries to reflect actual operating constraints on the FCRPS.
- Slice will be available by preschedule. Further negotiations may allow Slice to be made available by dynamic scheduling.

Operations/Management Influence

- Federal agencies will make decisions on non-power requirements and operations of the FCRPS.
- The purchaser would have no authority in river management, investment, or other management decisions.

Forecast and Data Needs

- Forecasted Constraints, study results and Data Supplied by BPA to the Slice purchaser will be defined in the Slice contract.

<i>Customized Product</i>	Environmentally Preferred Power
General	<p>Environmentally Preferred Power (EPP) is available to customers purchasing firm power under the Priority Firm (PF-02), Residential Load (RL-02), New Resources (NR-02), and the Industrial Firm Power (IP-02) rate schedules. EPP is available to customer's choosing to designate any portion (up to 100 percent) of their Subscription purchase as EPP. A Green Energy Premium (GEP) appropriate to the specific EPP selected by the customer, will be charged in addition to the customers firm power rate. By paying the GEP, BPA's customers acquire the marketing flexibility associated with EPP to meet the needs of environmentally conscious retail consumers. The amount of EPP that customers may designate will be limited by the availability of EPP resources and the individual customer's Subscription firm power purchase.</p>
Pricing	<p>The GEP will range from zero to \$40/MWh depending on the specific resource types selected by each customer. The negotiated GEP for any specific customer will be calculated by determining the difference between the customers average energy cost, based on the applicable loads and rate schedules and all applicable costs associated with the EPP. Such EPP costs may include, but are not limited to, the following:</p> <ul style="list-style-type: none"> • Costs of existing EPP resources, over and above the cost of BPA system resources. • Costs of new EPP resources, over and above the cost of BPA system resources. • Costs of BPA system resources. • Endorsement fees for specific EPP resources. • Market purchases of EPP resources matching customer specifications. • Transmission and other services required to integrate EPP resources into the BPA system.

<i>Customized Product</i>	Environmentally Preferred Power
Environmentally Preferred Resources	<p>Environmentally Preferred Resources may be made available from a variety of resources including:</p> <ul style="list-style-type: none"> • Endorsed Hydropower facilities • New or existing solar, wind, geothermal or biomass generating facilities <p>Availability of specific resources is subject to change.</p>
Term	Environmentally Preferred Power resources are available for terms of 1-5 years, beginning October 1, 2001 (if available).
Scheduling	EPP is not a scheduled power product.
Transmission	Transmission and ancillary services are not included as part of EPP.
Disclosure	BPA will provide the purchaser with periodic reports documenting the project source and power delivery schedules associated with this sale.
Payment	Take-or-Pay: Payment is based on monthly contract amounts.



NON-SUBSCRIPTION PRODUCTS



BPA POWER PRODUCTS CATALOG

<i>Bilateral Products</i>	<i>Power – Firm, Secondary, Commodity</i>
General	Non-Subscription power is a commodity product normally sold from BPA’s Trading Floor.
Term	Monthly amounts from 1-18 months, or annual blocks of power.
Transmission	Transmission and ancillary services are not included in this product.
Amount & Shape	As negotiated, but this product is commonly sold as monthly flat blocks of power: 100% load factor on LLH only, on HLH only, or on all hours.
Interruption Rights	Rights to interrupt schedules may be negotiated.
Basis for Payment	Payment is based on amount of power scheduled.



<i>Bilateral Products</i>	<i>Capacity</i>
General	<p>Capacity is a customer’s right to purchase and a supplier’s obligation to stand-ready to provide. The need addressed in the past by capacity-without-energy can be met partly by buys and sells from the commodity market rather than with a separate capacity product.</p> <p>The term “capacity without energy” (e.g., “naked capacity”) has been used to describe a common power product in which a supplier stands ready to supply a specified MW/hr level of power, generally in specified HLH only, and the receiver returns the energy in other hours.</p> <p>Additional product features might include cash-out in lieu of energy replacement, ability to defer acceptance of replacement energy, and flexibilities around notice or pre-schedule terms.</p>
Purchase Period	The purchase period of this product is negotiable.
Transmission and Ancillary Services	Transmission and Ancillary Services are not included in this product.
Amount and Shape	<p>The customer can specify the amount and shape including:</p> <ul style="list-style-type: none"> • Maximum number of hours per period during which the customer is able to schedule the capacity; • Maximum MW/hr to be scheduled; and <p>Hours of the day or week the service is required.</p>
Energy Returns	<p>Replacement energy must be returned during a specified time period (as negotiated), commonly within either 24 hours or 168 hours.</p> <p>The hourly maximum rate of return will be negotiated; a standard return rate could be 100 percent of the capacity amount.</p>
Linkages	None.
Basis for Payment	Payment is based on the amount of capacity specified in the contract.



BPA POWER PRODUCTS CATALOG

<i>Bilateral Products</i>	<i>Storage</i>
General	<p>Storage generally has been used to refer to actual use of hydro reservoir space and therefore was constrained by reservoir specifics. It sometimes was attached literally to the water stored but more commonly was measured in energy equivalents.</p> <p>This product generally involves the delivery and return of equal amounts of energy in specified time periods. It is designed for customers that want to deliver energy to BPA at a certain time and have it returned at another time.</p> <p>The product can be designed to include any of the following, but the seasonal shaping of water described in listed item 2 is the traditional use: (1) energy accepted from the customer in LLH and delivered to the customer in HLH, (2) energy accepted from the customer in the spring and returned to the customer in the winter, or (3) energy delivered to the customer in advance of energy being provided to BPA.</p>
Purchase Period	The purchase period of this product is negotiable.
Transmission and Ancillary Services	Transmission and Ancillary Services are not included in this product.
Amount and Shape	Amounts of BPA's storage capability vary daily. BPA will assess system conditions and provide storage capability within system limitations. Amounts and timing of storage may be negotiated on a preschedule basis.
Notification	Storage deliveries and returns will be conducted on a preschedule basis.
Spill Guarantee	This standard product is not guaranteed against spill.
Limitations	BPA may limit return of storage to a specified group of peak hours each day.



BPA POWER PRODUCTS CATALOG

<i>Bilateral Products</i>	<i>Storage</i>
Reservoirs	This storage is considered system storage and is not tied to a specific reservoir.
Accounting	BPA's normal storage accounting practices will be used.
Linkages	None.
Basis for Payment	Payment is based on amounts and periods when energy is stored and returned.

<i>Bilateral Products</i>	<i>Resource Factoring</i>
General	<p>The Resource Factoring product generally involves the delivery and return of equal amounts of energy in specified time periods. It is designed for customers that want to deliver energy to BPA at a certain time and have it returned at another time. It can be used for within day shaping of a resource.</p> <p>The product can be designed to include: (1) energy accepted from the customer in LLH and delivered to the customer in HLH, (2) energy accepted from the customer in the spring and returned to the customer in the winter, or (3) energy delivered to the customer in advance of energy being provided to BPA.</p>
Purchase Period	The purchase period of this product is negotiable.
Transmission and Ancillary Services	Transmission and Ancillary Services are not included in this product.
Amount and Shape	BPA will negotiate with the customer on a case-by-case basis for providing the services necessary to meet the customer's needs.
Firmness	This service may be firm or non-firm based on price and system conditions.
Limitations	BPA may limit delivery of this product to a specified group of peak hours each day.
Linkages	None.
Basis for Payment	Payment is based on the number of MW required to support the service and/or MWh accepted and/or returned.



<i>Bilateral Products</i>	<i>Preschedule Change Rights</i>
General	The Prescheduled Change Rights product provides the customer with the right to make changes to scheduled amounts previously set in the preschedule process, i.e., the workday prior to the day of delivery. It is assumed to be attached to an umbrella agreement or power sales contract specifying the limitations on preschedule change rights.
Purchase Period	The purchase period is up to the term of the underlying agreement.
Transmission and Ancillary Services	Transmission and Ancillary Services are not included in this product.
Amount and Frequency	The maximum MW/hr magnitude of the schedule change and the number of changes per hour will be specified in the underlying agreement.
Deadline	Changes from preschedules for the “hour ahead” would be accepted until a specified time prior to the beginning of that clock hour.
Linkages	This product is offered in conjunction with an underlying BPA purchase agreement.
Basis for Payment	Payment is based on rights: the amount (in MW) and frequency (in hours/month).

BPA POWER PRODUCTS CATALOG

<i>Bilateral Products</i>	<i>Displacement</i>
General	The Displacement product is designed to allow the customer to purchase less power from BPA than their commitment to purchase, for any reason. The customer can use this product in addition to the Block Flexibility product to supplement the ability to reduce BPA purchases. This product enables the customer to exercise economic choice in large amounts for limited periods.
Purchase Period	The purchase period is in one-calendar-month increments, not to exceed the term of the underlying agreement.
Transmission and Ancillary Services	Transmission and Ancillary Services are not necessary.
Amount and Shape	The product provides for displacement up to 100 percent of the BPA purchase.
Linkages	This product is offered in conjunction with a BPA power sale to the customer. The Displacement product does not relieve the purchaser from a demand charge in the underlying purchase.
Basis for Payment	Payment is based on amount of displacement right and amount of use.

<i>Complements to Core Products</i>	<i>Scheduling Services</i>
General	BPA can provide scheduling services for customers that purchase non-Federal power. (Scheduling fees will not be charged for power purchased by the customer from BPA.)
Purchase Period	The purchase period is up to the term of the purchase.
Types of Scheduling Services	<p>Scheduling services are customized, tailored to the type of agreement or resource, and to the specifications of individual customers.</p> <p>BPA can provide the following Scheduling services, if requested:</p> <ul style="list-style-type: none"> • <i>Daily prescheduling</i>: Daily prescheduling of transactions between utilities within the Western Systems Power Pool (WSPP). • <i>Real-time Activities</i>: Verification and coordination of the necessary interchange schedules with all parties involved, and coordination of all real-time changes in preschedules with all affected parties. • <i>After-the-Fact Activities</i>: After-the-fact verification and reconciliation of transactions. BPA will provide records of hourly schedules each day and cumulative total schedules at the end of each calendar month.
Conditions	<p>The customer will submit preschedule information (including hourly schedules, transmission arrangements, and control area contacts) by a specified time, each preschedule day.</p> <p>The customer will provide the name of the utility providing load regulation and reserves, for each schedule.</p> <p>BPA is not responsible for reserves or mitigating losses if no reasonable alternatives are provided.</p>
Linkages	This product is tied to a non-Federal purchase.
Basis for Payment	Payment is based on fee for services and the actual number of preschedules and real-time changes.



<i>Reserves, Resource Support</i>	<i>Supplemental AGC</i>
General	<p>This product is intended for control area operators.</p> <p>This product makes capacity available to either deliver or receive energy as needed on an instantaneous basis to cover a utility's load and resource variations.</p>
Purchase Period	The purchase period is up to 5 years, beginning October 1, 2001.
Transmission	Transmission is not included in this product.
Amount & Shape	Hourly capacity is pre-determined by the customer. The net amount of energy provided by BPA on any hour is determined by integrating the signal between BPA and the customer each hour.
Firmness	This standard product is sold on a firm basis.
Direction	The standard product is bi-directional.
Accounting	Amounts of energy will be integrated on an hourly basis.
Equipment	The customer is responsible for acquiring and purchasing the telemetry and communications channel that are required between the customer's control center and the BPA control center.
Linkages	None.
Basis for Payment	Payment is based on amount of capacity available on an instantaneous basis and amount of hourly or monthly net energy delivered or received.

<i>Reserves, Resource Support</i>	<i>Contingency (Operating) Reserves</i>
General	<p>This product is intended for control area operators.</p> <p>This product can be used to meet the customer's NWPP, WSCC, NERC or other reserve obligations within an hour. BPA offers Spinning and Supplemental (non-spinning) reserves that can be called upon in the event of a resource failure. Spinning reserves are provided from on-line generation that is responsive to changes in system frequency and are available within 10 minutes upon notification of a resource failure. Supplemental reserves are provided from generation that can be on-line within 10 minutes or load that can be interrupted within 10 minutes.</p>
Purchase Period	The purchase period is up to 5 years, beginning October 1, 2001.
Transmission	Transmission is not included in this product.
Amount	This can be up to the contracted amounts within 10 minutes of notification.
Energy Delivery	BPA will provide energy for up to 60 minutes.
Linkages	None.
Basis for Payment	Payment is based on amount of Operating Reserve capacity provided by BPA and amount of energy delivered.

<i>Reserves, Resource Support</i>	<i>Forced Outage Reserves</i>
General	Forced Outage Reserves provides reserves that can be called upon at the start of an hour in the event of a resource or transmission line failure.
Purchase Period	The purchase period is up to 5 years, beginning October 1, 2001.
Transmission	Transmission is not included in this product.
Amount	The amount is based on the size of resource or transmission line (MW), specified by customer, to be backed for the duration specified
Resource being supported	Back up is provided for forced outages on specific resources or transmission lines identified by the customer.
Duration of Energy Delivery	BPA will provide energy for the duration specified by the customer.
Linkages	This service can be packaged with Contingency Reserves and be available immediately upon notice of a resource or transmission line failure.
Basis for Payment	Payment is based on amount of Forced Outage Reserves (MW) held by BPA and amount of energy provided.

<i>Complements to Core Products</i>	<i>Retail Access – Remarketing Service</i>
General	Retail Access Remarketing is designed to mitigate take-or-pay purchase obligations, and continuing payment obligations resulting from retail load(s) lost by the customer due to retail competition or deregulation. Remarketing will result in a credit on the customer’s power bill.
Notice	The utility is required to provide to BPA’s AE (a) the name of the energy service provider and (b) the amount of retail load loss the utility would like BPA to remarket for the month two weeks prior to the beginning of each month. This information will be used for planning purposes by the trading floor and the operations staff.
Purchase Period	The purchase period is limited to the term of the underlying purchase agreement.
Transmission	Transmission and ancillary services are not included.
Amount and Shape	The amount of excess firm energy to be remarketed will be identified in advance and be limited to the customer’s load loss. The shape of the power to be returned to BPA for remarketing will match the shape of the lost load.
Limitations	Under certain market or system conditions, BPA may have a limited ability to remarket.
Load Variations	None; the amount is fixed. BPA and the customer must agree on the amount to be remarketed.
Linkages	This product is offered in conjunction with a BPA sale to the customer. It would not protect the customer from a take-or-pay obligation associated with load loss beyond the amount being remarketed by BPA.
Basis for Payment	The basis for payment is take-or-pay, with the payment based on the monthly contract amount. Fees will be charged, as necessary, to offset the cost of providing this service.



BPA POWER PRODUCTS CATALOG

<i>Complements to Core Products</i>	<i>Retail Access – Remarketing Service</i>
Remarketing Credit to the Utility Customer	The credit will be (mills/kWh).
Application of the Remarketing Credit	BPA will credit the utility customer based on the scheduled amounts of power serving that utility’s retail access loads.



<i>Complements to Core Products</i>	<i>Generation Management Service</i>
General	Generation Management Services (GMS) is designed for utilities with generating resources that are not dispatchable or for which the customer wishes to purchase management and dispatch services.
Product Description	<p>GMS is a category of products and services that deal with the output of a resource which either can't be controlled by its owner or as to which the owner wishes to contract with BPA for management services. The impacts of integrating uncontrollable or variable generation output can have business significance to BPA if the customer desires to purchase one of BPA's actual load-serving products -- Full Service or Actual Partial Service. GMS service charges, when appropriate, would compensate BPA for such impacts. Also, GMS can be assembled to fully support a firm planning capability for a resource in accordance with prevailing utility practices or to simply improve the usefulness of the output to serve load. Examples of GMS products and services include: :</p> <ul style="list-style-type: none"> • Replacement power to support Forced and Planned Outages (capacity and energy) • Firming services • Energy shaping services • Disposal of surplus <p>PBL will develop fees for service based on resource type, forced outage rating, schedule of expected output, and historical operating characteristics (if applicable).</p>
Availability	GMS is available to all customers with non-dispatchable generating resources. Similar services may be sold to non-utility owners of generating resources.
Billing Factor(s)	Customer bills will be based on a pre-negotiated amount based on the resource supported and its characteristics.
Purchase Period	The purchase period may vary from 1-5 years, beginning October 1, 2001.



<i>Complements to Core Products</i>	<i>Generation Management Services (GMS)</i>
<p>Resource Sizes and Relation to Full and Actual Partial Service</p>	<p>Resources with nameplate ratings of not more than 3 MW per resource or 6 MW total for the utility based on nameplate rating or demonstrated historical peak: These resources will not be subject to GMS service charges. For purchasers of Full Service or Actual Partial Service, the measured hourly amounts of power taken will be the measured load net of the actual output of these resources (measured amount netting).</p> <p>Resources with nameplate ratings of more than 3MWs per resource or 6 MWs total for the utility, but not more than 15 MW per resource or 50 MW total: These resources are presumed to be ineligible for measured amount netting unless the customer can prove non-dispatchability and is willing to compensate BPA for resource-specific services which may be associated with integrating its variable output.</p> <p>Resources with nameplate ratings of more than 15 MW per unit or 50 MW total: These resources are presumed to require services from some provider to establish and deliver a firm capability for declaration per BPA’s Actual Partial Service product resource declaration parameters, i.e., monthly HLH/LLH energy and peak declared amounts. If BPA is the service provider, the customer may be eligible for the Full Service product.</p>
<p>Transmission and Ancillary Services</p>	<p>This product does not include transmission or ancillary services FERC requires Transmission Providers to provide or offer. Ancillary services that may be applicable to resources in the BPA control area include regulating reserve, and contingency spinning and supplemental (non-spinning) reserves.</p>
<p>Pricing Construct</p>	<p>Using the FPS-96 Rate Schedule, the price is developed based on the type and characteristics of the resource, the pricing option selected and the package of services necessary to support the resource/purchase. Your BPA Account Executive will be able to provide you with more detailed resource/purchase product pricing options.</p>



BPA POWER PRODUCTS CATALOG

<i>Complements to Core Products</i>	<i>Generation Management Services (GMS)</i>
Associated Services	Individual resource support products and services similar to GMS may be priced and sold to any customer separately in or out of the BPA control area.
Termination Notice	GMS charges will be terminated when written notice is received that a resource is permanently out of service.

APPENDIX A
COMMONLY USED ACRONYMS

COMMONLY USED ACRONYMS

AGC	Automatic Generation Control
aMW	Average Megawatt
BPA	Bonneville Power Administration
CAER	Computer Average Energy Requirement
C&R Discount	Conservation and Renewables Discount
Con/Mod	Conservation Modernization Program
CSPE	Columbia Storage Power Exchange
CY	Calendar Year (Jan-Dec)
DC	Direct Current
DOE	Department of Energy
DSIs	Direct Service Industrial Customers
FBS	Federal Base System
FCRPS	Federal Columbia River Power System
FELCC	Firm Energy Load Carrying Capability
FERC	Federal Energy Regulatory Commission
FPS	Firm Power Products and Services (rate)
FY	Fiscal Year (Oct-Sep)
GRSPs	General Rate Schedule Provisions
GWh	Gigawatthour
HLH	Heavy Load Hour
IOUs	Investor-Owned Utilities
IP	Industrial Firm Power (rate)
ISO	Independent System Operator
kV	Kilovolt (1000 volts)
kW	Kilowatt (1000 watts)
kWh	Kilowatthour
LDD	Low Density Discount
LLH	Light Load Hour
L/R Balance	Load/Resource Balance
m/kWh	Mills per kilowatthour
MW	Megawatt (1 million watts)
MWh	Megawatthour
NERC	North American Electric Reliability Council
NLSL	New Large Single Load
Northwest Power Act	Pacific Northwest Electric Power Planning and Conservation Act
NR	New Resource Firm Power (rate)
NUG	Non-Utility Generation
NWPP	Northwest Power Pool
NWPPC	Northwest Power Planning Council
OY	Operating Year (Aug-Jul)



BPA POWER PRODUCTS CATALOG

PBL	Power Business Line
PDR	Power Discharge Requirement
PF	Priority Firm Power (rate)
PNCA	Pacific Northwest Coordination Agreement
PNUCC	Pacific Northwest Utilities Conference Committee
PNW	Pacific Northwest
POD	Point of Delivery
POM	Point of Metering
PSW	Pacific Southwest
PURPA	Public Utilities Regulatory Policies Act
PUD	Public or People's Utility District
RFP	Request for Proposal
RL	Residential Load (rate)
RMS	Remote Metering System
ROD	Record of Decision
SUMY	Stepped up multi-year (Block purchase)
TAC	Targeted Adjustment Charge
TBL	Transmission Business Line
TRL	Total Retail Load
UDC	Utility Distribution Company



APPENDIX B

CORE PRODUCTS BILLING FACTORS



Core Product Billing Factors

General information on this summary of core product billing factors:

◆ **Amounts Taken**

"Take" refers to the amount deemed to be taken by customer from BPA for purposes of core product billing. Take will be calculated from scheduled amounts, if customer is outside the BPA control area and takes by interchange schedule, or if memo-scheduled amounts are specified by contract as billing quantities. If the customer is within the BPA control area or served by GTA, take will be calculated from measurement of TRL from points of metering (POMs) minus output of resources eligible for measured amount netting (a.k.a. small/nondispatchable resources meeting BPA's criteria), and net of all other transfers to and from the customer.

◆ **Amounts Taken and Different Applicable Rates or Rate Adders.**

These billing factors do not attempt to separately identify amounts of requirements products and classes of power that may be subject to differentiated rates or rate adders per Subscription policies. Examples are loads subject to the New Resources rate such as new large single loads, targeted adjustment charges (TACs), conservation and renewable resource discounts, low density discount, Green Power premiums, rate impact mitigation arrangements, (stepped up multi-year) SUMY charges which may be applicable to a Block purchase which has increasing annual energy amounts per year over a multi-year term of commitment.

◆ **Retail Access Accounting Assumptions**

All billing factors are described assuming no retail access accounting complications. In event of retail access in a customer's service area, billing factors for the core products would be described to separately identify certain loads and transfers. The separate accounting would allow the core product billing process to be consistent with BPA's policy that the core products will not provide energy imbalance service for retail-supplied loads.





◆ **Product Assumptions Regarding Resource Deliveries Exceeding Load**

In calculating take, resource commitment amounts are only considered delivered when there is sufficient customer load to use them. The resource delivery amount excess to load is deemed 'spilled' unless a service has been contracted for.



Core Product Billing Factors

Demand	Demand Entitlement	Billing Demand	Unauthorized Increase ¹	Demand Adjuster ²
Full Service	Customer system peak (CSP) ³	Measured amount on BPA generation system peak (GSP) ³	N/A	no
Partial Service Complex	CSP minus declared resource peak capability	Same as entitlement	Any amount by which the largest single hourly take in HLHs exceeds entitlement	yes
Partial Service Simple	CSP minus resource declaration applicable to CSP hour	Same as entitlement	HLH hourly take on the customer's CSP that exceeds entitlement.	yes
Block	Contract Demand = HLH Block aMW	Same as entitlement	Any amount by which the largest single hourly take in HLHs exceeds entitlement	no
Block w/ Shaping Capacity	Contract Demand = HLH Block aMW plus additional Shaping Capacity amount	Same as entitlement	Any amount by which the largest single hourly take in HLHs exceeds entitlement	no
Block w/ Factoring ⁴	Greater of: (1) CSP minus declared resource peak capability if any or (2) Block aMW.	Same as entitlement	Any amount by which the largest single hourly take in HLHs exceeds entitlement	yes

Core Product Billing Factors



HLH Energy	HLH Entitlement	HLH Billing Factor ⁵ 	HLH UAI ^{1, 5}  
Full Service	HLH TRL, reduced by contractually approved resource amounts (e.g., CSPE) or output of resources contractually approved for measured amount netting.	Sum of HLH entitlement amounts	Not applicable unless separate accounting must be done to identify retail access-related imbalance.
Partial Service Complex	HLH TRL, reduced by output of resources contractually approved for measured amount netting, minus HLH resource commitment amounts.	Sum of HLH entitlement amounts.	Monthly HLH takes in excess of the HLH entitlement.
Partial Service Simple	HLH TRL, reduced by output of resources contractually approved for measured amount netting, minus HLH resource commitment amounts.	Sum of HLH entitlement amounts.	Sum of take in excess of entitlement amounts.
Block	Contracted Block amounts, i.e., HLH MW amount specified per contract -- for each HLH of month.	Same as entitlement.	Sum of HLH takes in excess of entitlement
Block w/ Shaping Capacity	Monthly - the original Block amount. In any HLH, the Block HLH MW amount plus or minus not more than the Shaping Capacity (in whole MWs). ⁶ 	Same as original Block Entitlement.	Sum of the daily excess amounts. The daily excess is the greater of: (1) the sum of the hourly takes in excess of the contracted amount of Block with Shaping Capacity, or (2) the daily take in excess of the daily energy maximum amounts, including hourly take or pay minimums. ⁷ 
Block w/ Factoring	Contracted Block amounts, i.e., HLH MW amount specified per contract -- for each HLH of month.	Same as original Block Entitlement.	Monthly HLH take in excess of the HLH Entitlement



Core Product Billing Factors

LLH Energy	LLH Entitlement	LLH Billing Factor ⁵ 	LLH UAI ^{1, 5}  
Full Service	Same method as for HLH energy.	Monthly entitlement	Same method as for HLH energy.
Partial Service Complex	Same method as for HLH energy.	Monthly entitlement	Same method as for HLH energy.
Partial Service Simple	Same method as for HLH energy.	Monthly entitlement	Same method as for HLH energy.
Block	Same method as for HLH energy.	Monthly entitlement	Same method as for HLH energy.
Block w/ Shaping Capacity	<i>Not available in LLH</i>	<i>Not available in LLH</i>	<i>Not available in LLH</i>
Block w/ Factoring	Same method as for HLH energy.	Block entitlement unchanged	Same method as for HLH energy.

Core Product Billing Factors

8 

Within Day Factoring (HLH & LLH)	Allowable Factoring	Excess Factoring
Full Service	N/A	⁹ 
Partial Service Complex	Limited by TRL within day shape. See the partial service products team report & appendices for details.	The sum of the daily amounts by which within day factoring of the BPA take exceeds the limit.
Partial Service Simple	N/A	¹⁰
Block	N/A	¹⁰ 
Block w/ Shaping Capacity	N/A	¹⁰
Block w/ Factoring ⁴ 	Limited by TRL within day shape	The sum of the daily amounts by which within day factoring of the BPA take exceeds the limit.

Within Month Factoring (HLH & LLH)	Allowable Factoring	Excess Factoring
Full Service	N/A	⁹ 
Partial Service Complex	Any daily diurnal amount within boundaries that are between flat and following the diurnal load shape. See the partial service products team report & appendices for details.	The greater of (1) the sum of excesses above the upper boundary or (2) the sum of the excesses below the lower boundary.
Partial Service Simple	N/A	¹⁰
Block	N/A	¹⁰ 
Block w/ Shaping Capacity	N/A	¹⁰
Block w/ Factoring ⁴ 	Any daily diurnal amount within boundaries that are between flat and following the diurnal load shape. See the partial team report for details.	The greater of (1) the sum of excesses above the upper boundary or (2) the sum of the excesses below the lower boundary.

Core Product Billing Factors

Load Variance	Load Variance Billing Factor
Full Service	Total Retail Load (TRL)
Partial Service Complex	TRL
Partial Service Simple	TRL
Block	N/A, unless via Actual Partial Service product purchased in combination with Block
Block w/ Shaping Capacity	“”
Block w/ Factoring	“”

Core Product Billing Factors

¹ Unauthorized Increase Demand and Unauthorized Increase Energy are assessed independently. It is possible to incur both charges on the same hour.

² The demand adjuster equalizes the demand billing between Full and Partial Service products. As defined in the GRSPs, the Demand Adjuster is applied to a customer's demand billing factor. It is a number less than or equal to one calculated by dividing the customer's Total Retail Load on the Generation System Peak by the customer's Total Retail Load on their system peak. The minimum Demand Adjuster is 0.6 (six tenths). Partial service product design considerations required that partial service products use demand billing factors other than amount of take on the BPA GSP hour.

³ CSP: Customer System Peak in HLHs. GSP: BPA's Generation System Peak in HLHs.

⁴ Block w/ Factoring is a "declared resource" product. Customer will declare monthly HLH/LLH energy and peak resource amounts.

⁵ Core product billing energy and UAI billing energy will be calculated from (a) the sum of hourly amounts where the load or resource or class of power has a contractually specified hourly amount, and (b) the HLH monthly amounts for loads or resources or classes of power which are contractually specified in monthly quantities.

⁶ Use of Shaping Capacity must be energy-neutral day by day. Shaping is only among hours within day. Shaping Capacity is used by preschedule only.

⁷ If the Block with Shaping Capacity purchaser is within the BPA CA, the amount deemed to be taken for any hour for billing and UAI purposes will not be less than the amount prescheduled even if the after the fact measured take amount is less.

⁸ The information in this table is highly condensed. See the partial service products team report & appendices for details. Excess within month factoring amounts for the month for HLHs and LLHs will be reduced by any HLH or LLH Unauthorized Increase energy charged for the month.

⁹ Per BPA product design, a Full Service customer cannot take excess factoring and is not subject to the factoring test.

¹⁰ These products are not subject to the factoring benchmark test. Failure to take the correct hourly energy amount is reflected in the energy and demand UAI charges.

