

# Montana Renewables Development Action Plan

June 2018



Bonneville  
POWER ADMINISTRATION



Copies of this report are available on the Bonneville Power Administration website:  
[www.bpa.gov/Projects/Initiatives/Montana-Renewable-Energy/Pages/Montana-Renewable-Energy.aspx](http://www.bpa.gov/Projects/Initiatives/Montana-Renewable-Energy/Pages/Montana-Renewable-Energy.aspx)

This document is intended to represent a general consensus of participants. As such, any statement in this document may not necessarily represent the views of all participants.

All decisions, options or recommendations identified in this report regarding BPA are subject to additional subsequent public processes, such as a BPA rate case, tariff revision process or policy process, where BPA will make independent decisions before they may be adopted. In those subsequent public processes, BPA is not required or obligated to support or defend the decisions, options or recommendations identified in this report. In addition, participating jurisdictional entities are subject to state and Federal Energy Regulatory Commission filings and other regulatory requirements before adoption.

# Contents

<b>Letter from Montana Governor and Bonneville Power Administrator</b>	<b>2</b>
<b>Project leadership: Support for recommendations</b>	<b>4</b>
<b>Participating organizations and individuals</b>	<b>5</b>
<b>Introduction</b>	<b>7</b>
<b>Significant findings: Ability of Montana to provide renewables to the Northwest</b>	<b>10</b>
<b>Recommendations and action items</b>	<b>16</b>
<b>Next steps</b>	<b>19</b>
<b>Appendix</b>	<b>20</b>
<i>Appendix A: Commercial Policy Subcommittee</i>	
<i>Appendix B: Planning Subcommittee</i>	
<i>Appendix C: Operations Subcommittee</i>	
<i>Appendix D: Interface Capacity Settlement Agreement between Bonneville and Northwestern Energy</i>	
<i>Appendix E: Montana to Pacific Northwest existing system and capacity</i>	
<i>Appendix F: Memorandum: The Colstrip Transmission System—Its Value to Montana and Planning for its Future</i>	
<i>Appendix G: Statement on market principles</i>	
<i>Appendix H: Existing Studies for Montana coal shutdown</i>	
<i>Appendix I: WECC Path 8</i>	
<i>Appendix J: Acronyms</i>	



## To our Regional Partners

We are very pleased to release the Montana Renewables Development Action Plan, which clearly demonstrates the value of bringing a diverse group together from across the region for robust, honest and informed conversations to advance our mutual interests. We appreciate all of the participants who worked to make this an effective, informative and timely process to explore the different aspects of renewable resource development in Montana.

When we started this process in December 2017, our primary goal was to improve regional understanding of the opportunities and barriers to developing renewable resources in Montana and delivering that power to Northwest markets, where there is a growing demand for clean energy resources. Today, we have a much better shared understanding of what is needed to successfully develop new resources, and we have made real progress toward addressing the issues.

By bringing together the many parties who have a stake in these issues and studying them through an integrated, regional lens, we learned that nearly 360 megawatts of transmission capacity is available today to move power from Montana to the Pacific Northwest. We resolved a lingering issue around who can market 184 megawatts of capacity that is available to transfer energy from Montana to the west, which will create more certainty for transmission purchasers. And we determined there is sufficient capability in the existing transmission system to dynamically transfer 1,000 megawatts of variable energy resources to West Coast states.

In addition, we have made recommendations and identified actions that will continue to improve the ability of West Coast markets to access renewable generation in Montana.

Going forward, no single issue or action will result in opening Montana to renewable energy development. This action plan moves things forward substantially, but there is still work to do. Some of the actions will require bilateral and multilateral conversations, and

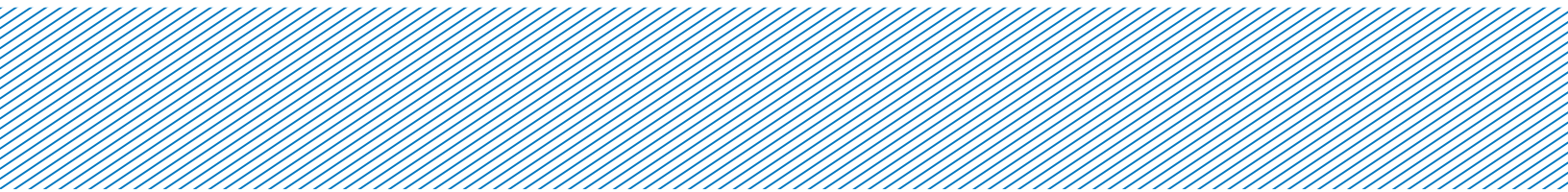

some of them will require other public processes, including some specific to Bonneville. As Montana seeks to increase its capacity to supply renewable resources within the region, there must be an equal demand from utilities seeking clean energy.

Most importantly, Montana continues to seek opportunities to further develop its renewable energy resources, providing good-paying jobs for Montanans, strengthening rural communities and supporting local schools, while protecting its quality of life. Montana is ready to help the region achieve its environmental and clean energy goals by complementing existing hydropower and other renewable generation in the Pacific Northwest. Through constructive partnerships like this one, we are moving forward to achieve those objectives.

We would like to thank all of the participants for bringing a collaborative attitude to the discussions and advancing the prospect of renewable energy development in Montana. We particularly extend our sincere gratitude to the steering committee members and workgroup co-chairs.

Sincerely,

**Steve Bullock**  
Governor,  
State of Montana

**Elliot Mainzer**  
Administrator and CEO,  
Bonneville Power Administration

# Project leadership: Support for recommendations

The following report reflects the efforts of a broad set of participants over six months to examine barriers and provide recommendations designed to enable development of Montana renewable resources and their delivery to the Pacific Northwest. The co-leads of the project's Commercial Policy, Planning, and Operations Subcommittees and the Steering Committee support the high-level findings and recommendations contained in the Montana Renewables Development Action Plan.

## Steering Committee co-leads

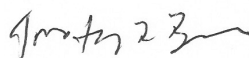

**Tim Baker**  
Montana Governor's Office  
and Northwest Power and  
Conservation Council



**Mike Cashell**  
NorthWestern Energy

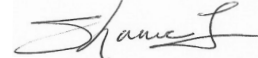

**Shauna Tran**  
Puget Sound Energy

## Commercial Policy Subcommittee co-leads



**Brian Altman**  
Bonneville Power Administration

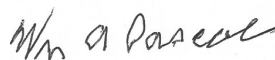

**Bill Pascoe**  
Representing Orion Renewable Energy

## Planning Subcommittee co-leads



**Patrick Rochelle**  
Bonneville Power Administration



**Cameron Yourkowski,**  
Renewable Northwest

## Operations Subcommittee co-leads

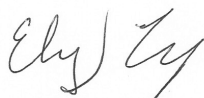

**Libby Kirby**  
Bonneville Power Administration



**Casey Johnston**  
NorthWestern Energy

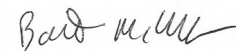

**Bart McManus**  
Bonneville Power Administration

# Participating organizations and individuals

## Sponsors

Steve Bullock, Governor, State of Montana

Elliot Mainzer, Administrator, Bonneville Power Administration

## Facilitation

Vickie VanZandt, Facilitator

Brian Dekiep, Northwest Power and Conservation Council

Joshua Warner, Bonneville Power Administration

## Steering Committee

Tim Baker, Montana Governor's Office and Northwest Power and Conservation Council (co-lead)

Michael Cashell, NorthWestern Energy (co-lead)

Shauna Tran, Puget Sound Energy (co-lead)

Larry Bekkedahl, Portland General Electric

Carl Borgquist, Absaroka Energy

Johnny Casana, Pattern Energy Group

Jeff Cook, Bonneville Power Administration

Scott Corwin, Public Power Council

Michael Cressner, Orion Renewable Energy

Patrick Damiano, ColumbiaGrid

Brian Fritz, PacifiCorp (alternate)

Michael Hagood, Idaho National Laboratory

Travis Kavulla, Montana Public Service Commission

Scott Kinney, Avista

Joe Lucas, Western Montana Generation and Transmission

Lauren McCloy, Washington Governor's Office

Chuck Magraw, Natural Resources Defense Council

Rita Meyer, Rocky Mountain Power – PacifiCorp (primary)

Bill Pascoe, representing Orion Renewable Energy

Laura Raypush-Dombrowsky, PacifiCorp (alternate)

Rachel Shimshak, Renewable Northwest

Jason Smith, Montana Governor's Office, Indian Affairs

## Commercial Policy Subcommittee

Brian Altman, Bonneville Power Administration (co-lead)

Bill Pascoe, representing Orion Renewable Energy (co-lead)

Robin Arnold, Montana Public Service Commission

Carl Borgquist, Absaroka Energy

Michael Cressner, Orion Renewable Energy

Mike Deen, Public Power Council

Brian Dekiep, Northwest Power and Conservation Council

Brian Fadie, Montana Environmental Information Center

Tom Flynn, Puget Sound Energy

Shaun Foster, Portland General Electric

Jeff Fox, Renewable Northwest

Stacy Gasvoda, Haymaker Wind

John Goroski, Flathead Electric Co-op

Laura Hatfield, Puget Sound Energy

Nate Hill, Puget Sound Energy

Doug Howell, Sierra Club

Joe Lucas, Western Montana Generation and Transmission

Chuck Magraw, Natural Resources Defense Council

George Marshall, Puget Sound Energy

Brendan McCarthy, Portland General Electric

Andrew McLain, NorthWestern Energy

Larry Nordell, Montana Consumer Council

Bill Pascoe, representing Orion Renewable Energy

Laura Raybush-Dombrowsky, PacifiCorp

Diego Rivas, Northwest Energy Coalition

Jeff Schlect, Avista

Mike Scott, Sierra Club

Lauren Tenney Denison, Public Power Council

Shauna Tran, Puget Sound Energy

## Planning Subcommittee

Pat Rochelle, Bonneville Power Administration (co-lead)

Cameron Yourkowski, Renewable Northwest (co-lead)

Eli Bailey, Absaroka Energy

Don Bauer, Northwestern Energy

Scott Beyer, PacifiCorp

Jon Cichosz, Portland General Electric

Patrick Damiano, ColumbiaGrid

Bob Decker, Montana Public Service Commission

Brian Dekiep, Northwest Power and Conservation Council

Ray Ellis, Lincoln Electric Co-op

Tom Flynn, Puget Sound Energy

Jennifer Galaway, Portland General Electric

Fred Huette, Northwest Energy Coalition

Tom Kaiserski, Montana Governor's Office

Chelsea Loomis, Northwestern Energy

Phillip Popoff, Puget Sound Energy

Bill Pascoe, representing Orion Renewable Energy

Tracy Rolstad, Avista

Tom Schneider, private citizen

Bill Shemley, PacifiCorp

Ed Weber, HDR, Inc.

## Operations Subcommittee

Libby Kirby, Bonneville Power Administration (co-lead)

Casey Johnston, Northwestern Energy (co-lead)

Bart McManus, Bonneville Power Administration (co-lead)

Laura Anderson, Montana Governor's Office

Thomas Bagnell, Puget Sound Energy

Jeff Blend, Montana Governor's Office

Brian Dekiep, Northwest Power and Conservation Council

Kathee Downey, PacifiCorp

Shaun Foster, Portland General Electric

Dustin Herrick, PacifiCorp

Rob Hovsopian, Idaho National Laboratory

Rhett Hurless, Absaroka Energy

Rich Hydzik, Avista

Ken Neal, NaturEner

Bill Pascoe, representing Orion Renewable Energy

Tom Schneider, private citizen

Pete Simonich, Missoula Electric Co-op

Evan Sorrell, Puget Sound Energy

Dean Spratt, Avista

Mike Starrett, Northwest Power and Conservation Council

Ed Weber, HDR, Inc.

Cameron Yourkowski, Renewable Northwest

## Editor

Kristel Turner, Bonneville Power Administration



# Introduction

As the Pacific Northwest's energy economy increasingly relies on clean energy, the state of Montana has an opportunity to play a significant role by growing its renewable resource base. Montana currently has more than 700 megawatts of installed wind capacity, but data shows that the state has the potential to develop significantly more renewable resources. This paper addresses the barriers to tapping Montana's renewable energy potential.

## Background

Over the last decade, renewable resources in the Northwest have grown exponentially. In 2005, the Northwest Power and Conservation Council's (Council) Fifth Power Plan identified up to 6,000 megawatts of developable and potentially cost-effective wind power in the region. The power plan also recognized barriers and uncertainties surrounding the development of wind power. Accordingly, the Council called for a strategy to resolve those uncertainties. In response, a broad assembly of stakeholders produced the Northwest Wind Integration Action Plan in March 2007, and many of that plan's action items have been achieved. Today, more than 7,800 megawatts of wind capacity is installed in the Northwest.

Eleven years later, this Montana Renewables Development Action Plan supplements that plan to specifically address potential barriers to development of wind and other renewable resources in Montana.

The action plan is the result of a partnership between the state of Montana and the Bonneville Power Administration with critical contributions from stakeholders, who jointly hosted a series of conversations focused on the potential to develop a sustainable long-term strategy to support the development of potential new renewable energy resources in Montana. The extensive participation of many parties, including public and private utilities, regulators, advocates and renewable resource developers, has improved regional understanding of the opportunities and barriers to development of renewable resources in Montana. Through this collaboration, the region is moving forward to make new resources in Montana a reality.

Several developments are driving the focus on this geographic area:

- The cost of utility-scale renewable resources continues to decline.

- Although there is not an abundance of flexible reserves, utilities have gained experience and developed new tools for integrating renewables.
- Montana adopted a renewable portfolio standard of 15 percent by 2015.
- Oregon's renewable portfolio standard calls for 25 percent by 2025, and 50 percent by 2040.
- Washington's current renewable goal is 15 percent by 2020.
- Utilities are actively soliciting bids for renewable resources in the Pacific Northwest, not only to meet regulatory requirements, but to serve voluntary green power programs and the need for energy and capacity generally.
- Production tax credits for wind energy production and the investment tax credits for solar energy production will begin to phase out by the end of 2019, which means wind and solar resources will be most competitive in the near term.
- Units 1 and 2 of the Colstrip coal-fired power plant in Montana will retire from power production no later than 2022.

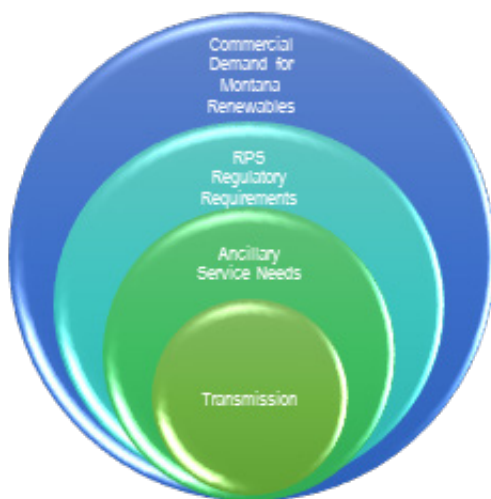

## Factors influencing the development of renewables in Montana

The factors influencing the development of Montana's renewable resources are nested, with the availability of transmission being an important element. Other trans-

mission factors include transmission service rates and how transmission providers manage their queues for providing new transmission service. Developers must also acquire the ancillary products and services needed to balance and move the energy to load, as well as consider the characteristics the resources must have to count toward the renewable portfolio standard requirements of the western states. These are all elements of supply and demand, which will ultimately determine how much and how soon Montana-based renewable generation will be acquired by purchasers outside of Montana.

The intent of this project was to explore the physical and process issues facing Montana renewable resource development. The project arose from a diverse array of interested stakeholders with a mutual desire to explore the opportunities and challenges facing that development. The project's activities have culminated in this action plan, which includes an exploration of these nested issues, clarification of facts, development of a range of potential solutions to each of the barriers identified, and recommendations for resolution.

This effort has produced significant findings regarding the ability of Montana to provide renewable resources to the Pacific Northwest and has resulted in recommendations to enable this resource development. This action plan identifies 28 significant findings and 19 actions intended to remove barriers to the development and export of Montana renewable resources.

## Project structure

The project was sponsored by Montana Governor Steve Bullock and BPA Administrator Elliot Mainzer. It was organized in a structure of three working subcommittees, guided by a steering committee. The work addressed (1) commercial policy, (2) planning, and (3) operational issues.

The three subcommittees worked collaboratively toward consensus of recommendations to resolve issues. All decisions, options or recommendations developed in this process regarding BPA are subject to additional subsequent processes, such as a BPA rate case, tariff filing or policy process before they may be adopted. In addition, jurisdictional entities are subject to state and Federal Energy Regulatory Commission filings and other regulatory requirements before adoption.

## Summary of conclusions

The project subcommittees concluded that the environment for Montana renewables development is positive and would be enhanced by the actions recommended in this report beginning on Page 16. One of the project's significant conclusions is that the delivered cost of Montana renewables appears to be competitive with other renewable resources in the Northwest.

Even without further action, this process identified enough transmission capacity to move 360 megawatts of new renewables from Montana to parts of the Northwest. More transmission capacity will be available after the retirement of two units at the Colstrip Power Plant by no later than 2022, and the capacity could be increased further with the investment of relatively minor transmission upgrades, compared to the cost of building new transmission lines.

The process found that the existing transfer capability of the Colstrip Transmission System can, with relatively minor investments (compared to new line builds), support a one-for-one replacement of Colstrip generation with new resources, including variable energy resources.

In addition, there is enough available Dynamic Transfer Capacity (DTC) today at the Garrison interchange to accommodate the dynamic transfer of over 1,000 megawatts of wind. DTC is necessary for integrating variable resources—it is consumed when resource output fluctuates within the operating hour. The existing DTC can be doubled at relatively low cost if necessary.

Some of the actions identified in this process have already been completed. For example, BPA and NorthWestern Energy resolved a long-standing dispute over 184 megawatts of available transmission capacity from Montana to BPA. The resolution gives certainty to potential transmission customers looking for transmission capacity from Montana to markets in the west. Going forward, potential purchasers can acquire transmission capacity from either BPA or NorthWestern. If requested from NorthWestern, the capacity will be purchased from BPA at BPA's posted rate, and will result in the provision of a continuous path from Montana to BPA's network without being charged BPA's Montana Intertie rate. The Colstrip parties will receive any appropriate credit for any capacity purchased from BPA.<sup>1</sup>

By following through on the remaining action items, the conditions for developing renewable resources would be further enhanced. These recommended actions range from modifying transmission agreements that may be needed to enable other parties to use the Eastern Intertie, to following through with work underway to relieve congestion on BPA's system to aid in delivery to Pacific Northwest load centers.

---

<sup>1</sup> Details of the agreement between NorthWestern and BPA can be found at Appendix D. The resolution must be approved by FERC.

# Significant findings: Ability of Montana to provide renewables to the Northwest

The working subcommittees made a number of findings that frame the action items. Additional detail regarding these findings is provided in the appendix.

The transmission system in Montana is comprised of several owners' facilities, represented in Figure 1.

## Major Montana Transmission

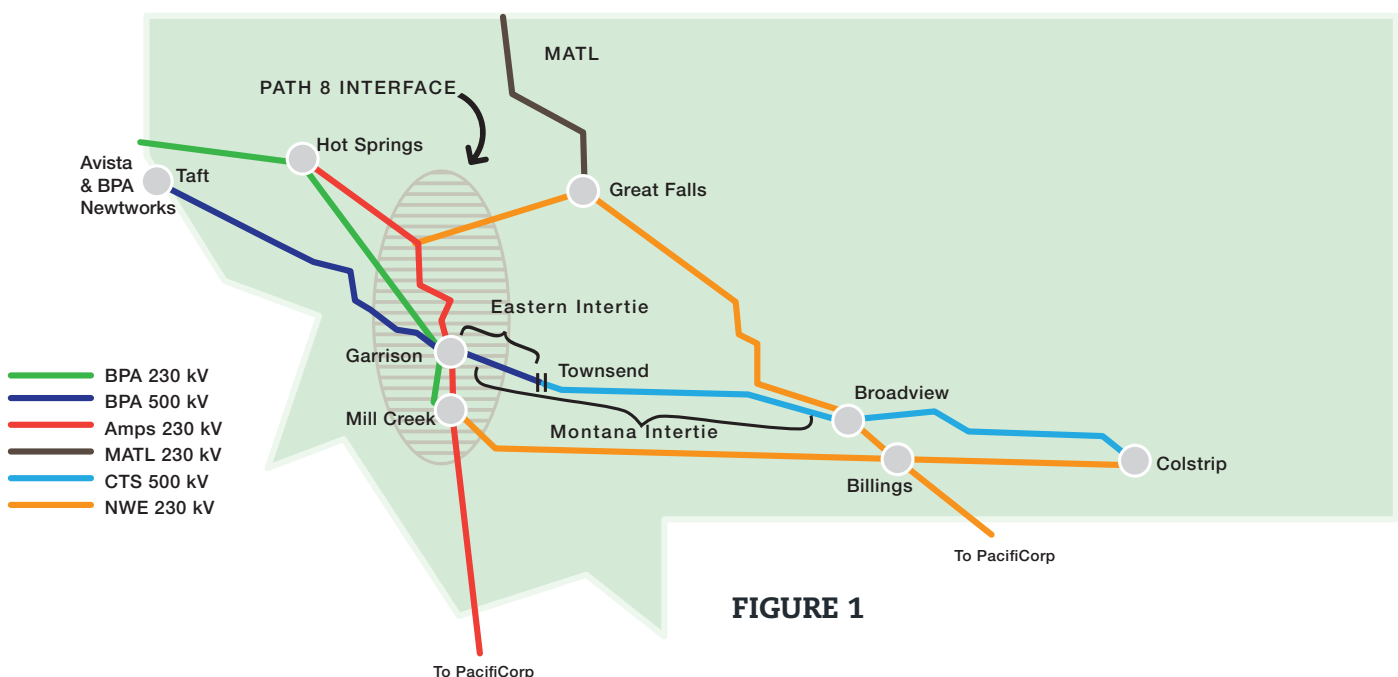

FIGURE 1

1

Advocates for Montana renewables (state government, developers and public interest groups) are “pushing” the export of Montana renewables. There needs to be a corresponding interest from potential purchasers “pulling” for the acquisition of Montana renewables.

2

The delivered cost of Montana wind resources to Pacific Northwest utilities appears to be competitive with other renewable resources. However, uncertainties about transmission and integration services can be impediments to securing contracts for Montana wind resources.

3

There is (or will soon be) a significant amount of transmission capacity – from existing available capacity, the planned retirement of Colstrip units 1 and 2, and relatively low-cost (compared to building new lines, though still in the \$ millions) transmission upgrades – to support the development of a substantial quantity of Montana renewables for export to the Pacific Northwest, but not necessarily all the way to the Interstate-5 (I-5) load centers.

4

Some segments of unused transmission system capacity exist today (Table 1, page 13).

5

Transmission system capacity will become available as coal-fired generation at Colstrip retires (see Table 2, page 13).

6

Assuming transmission service requests to pay for the investments, incremental available transmission capacity can be added with three projects (Table 2):

- a. BPA Remedial Action Scheme (RAS) installations - ~ \$2 million per site
- b. Colstrip Transmission Upgrade - ~\$252 million
- c. Montana-to-Washington Project - ~\$140 million

7

The Montana Intertie Agreement (MIA), originally conceived and written to move Colstrip generation to loads, has provisions that may need to be modified to facilitate future use of capacity on the BPA Eastern Intertie and the Colstrip Transmission System (CTS). BPA and the CTS parties agree that CTS parties can use their existing capacity rights under the MIA to move power they acquire other than Colstrip power, but some modification to the MIA is required to provide for third-party wheeling.

8

The existing transfer capability of the Colstrip Transmission System can, with relatively minor investments (compared to new line builds), support a one-for-one replacement of Colstrip generation with new resources, including variable energy resources.

9

As long as the Colstrip 500-kV transmission system remains intact and with proper enhancements, steady state and dynamic studies indicate new transmission lines are not required to reliably maintain high transfer capability.

10

The 500-kV system is also essential for reliable load service both within Montana and for supporting exports to the Pacific Northwest.

11

New generation must participate in Remedial Action Schemes, or RAS, the ability to quickly drop generation to protect the stability of the transmission system, and coordinate with the Colstrip Transmission System Acceleration Trend Relay (ATR) as long as the ATR or its replacement are required for the operation of the transmission system.

12

Under steady state conditions, review of the publicly available studies performed to date did not identify thermal limit violations for any of the Colstrip retirement scenarios considered. None of the studies identified new transmission lines as being required (as long as the 500-kV system is intact) in order to support the integration of new resources, including variable energy resources.

13

Review of the available studies that conducted dynamic stability analysis also found that the system performed reliably under stress, with no voltage excursions. Specific location and resource design will be reviewed for any necessary frequency response when replacement generation is identified.

14

Adequate voltage support in local areas may be a concern following Colstrip generation retirement. However, the location of replacement generation may help address it. Voltage control can be provided by a number of means, including generators, switched capacitors and reactors, static VAR compensators, pumped storage, or synchronous condensers.

15

Blackstart, sub-synchronous resonance mitigation, RAS, and Western Electricity Coordinating Council path rating requirements can be addressed at the time of Colstrip unit retirements when the location and type of replacement generation is known.

16

Variable energy resources will need to participate in RAS, provide local voltage support and potentially frequency response. Retaining Colstrip units to serve as synchronous condensers (to provide voltage support and inertia) may be an option. The choice to exercise it would depend on detailed engineering studies when replacement generation location and characteristics are identified and all owners agree that it represents the best value alternative for provision of voltage support and inertia needs. Other potential options for inertia, voltage support, and frequency response are also available (i.e., pumped storage).

**Table 1**  
**Available transmission capacity  
for Montana exports (2019)<sup>2</sup>**

	East of Garrison	West of Garrison	West of Hatwai	Cross Cascades
NWE to AVA to Mid-C	297	360	360	0
NWE to BPA	246	0	0	0
Montana Intertie	184	0	0	0
<b>Total</b>	<b>727</b>	<b>360</b>	<b>360</b>	<b>0</b>

**Table 2**  
**Potential incremental additions to transmission  
capacity for Montana exports post 2022**

	East of Garrison	West of Garrison	West of Hatwai	Cross Cascades
BPA RAS Upgrade	0	200	200	0
PSE Colstrip 1&2 <sup>3</sup>	300	300	300	300
Montana-to-Washington Project	0	600	550	0
Colstrip Transmission Upgrade	800	0	0	0
<b>Total Incremental</b>	<b>1,100</b>	<b>1,100</b>	<b>1,050</b>	<b>300</b>
<b>Total with Existing ATC</b>	<b>1,827</b>	<b>1,460</b>	<b>1,410</b>	<b>300</b>

<sup>2</sup> The ATC in this table is for informational purposes only and compiled from publicly available sources.

<sup>3</sup> PSE's available transmission on the Colstrip Transmission System is managed by PSE's transmission function and posted on OASIS. Transmission rights on the BPA network west of Garrison are contracted and managed by PSE's merchant function and can be reassigned or redirected. The 300 MW from Colstrip to PSE's balancing authority area in 2022 is not reflective of the ATC currently posted on OASIS.

17

A significant amount of dynamic transfer capability (DTC) is available to support development of over 1,000 MW of Montana wind for export to the Pacific Northwest. DTC is necessary for compliance with Washington State's current renewable portfolio standard and enables options for integrating Montana wind in Pacific Northwest balancing authorities.

18

NorthWestern Energy does not have a DTC limit on its system.

19

DTC of +/- 170 MW (340 MW dynamic range) is available at the Garrison interchange point.

20

The capacity of wind generation that can be integrated is much greater than the DTC across the Montana Intertie. This amount is dependent on a number of factors, including the diversity of the wind generation and the location of the balancing resources.

21

DTC is only consumed when resources are moving around within the hour. More than 1,000 MW of Montana wind can be accommodated within the current limit with no changes.

22

If movement in one direction is not deemed to consume DTC on the Montana Intertie, integration of more than 1,400 MW of wind can be accommodated within the current limit.

23

DTC can be increased (approximately doubled) by automating voltage control actions on transmission reactive devices. This option would be low cost.

24

There are no DTC limitations between BPA and other Northwest parties. The DTC on the Montana Intertie is the limiting factor. If DTC on the Montana Intertie is significantly increased in the future, interchange points further west may then be limiting.

25

Because of diversity benefits, if a wind plant located in Montana is integrated with wind resources in or near the Columbia River Gorge, the incremental increase in the balancing reserve requirement is only 25 percent that of a same size plant in the Gorge.



26

There are potential flexible capacity resources on the eastern side of the Montana Intertie (e.g., pumped storage). Because these resources would be on the same side of the intertie as the potential wind, their use for balancing would lessen the DTC impact.

27

Many of the transmission and integration challenges faced by Montana developers could be mitigated by the development of a Pacific Northwest regional transmission organization. However, formation of a regional transmission organization is a complex endeavor with potentially significant cost and governance issues.

28

State elected officials and regulators have authority to establish policies regarding the selection of resources used to serve electric consumers in their jurisdictions. While recognizing state prerogatives in setting policies, state renewable portfolio standards should consider the impacts of additional eligibility requirements on out-of-state renewable resources, and the propriety of imposing such requirements.

# Recommendations and action items

A summary of the recommended actions follows. Completed actions are colored green. Additional detail regarding these recommendations is provided in the appendix.

Recommendations & Action Items	Parties & Status
<p>1) BPA and the Colstrip Transmission System (CTS) owners should review the Montana Intertie Agreement (MIA) and the CTS Agreement and make modifications, as necessary, to facilitate future utilization of the Montana Intertie and CTS based on non-discriminatory, open access principles, and with the timing of production tax credits in mind. Possible modifications include:</p> <ul style="list-style-type: none"><li>a) Addressing third-party and non-Colstrip use.</li><li>b) Reviewing the appropriateness of the CTS and MIA five percent loss rate for third-party use.</li></ul>	<ul style="list-style-type: none"><li>• Avista</li><li>• BPA</li><li>• NorthWestern Energy</li><li>• PacifiCorp</li><li>• Portland General</li><li>• Puget Sound Energy</li></ul> <p>Parties are currently meeting to address repurposing the transmission following Colstrip unit retirement and will include the loss rate as well.</p>
<p>2) Montana renewables project developers should present credible and executable transmission plans to potential purchasers. Purchasers considering Montana renewables should allow a reasonable period after a resource is identified for acquisition to work with the developer to execute the transmission plan.</p>	<p><b>Developers:</b></p> <ul style="list-style-type: none"><li>• Absaroka</li><li>• NaturEner</li><li>• Orion</li><li>• Pattern</li></ul> <p><b>Potential purchasers:</b></p> <ul style="list-style-type: none"><li>• Avista</li><li>• PacifiCorp</li><li>• Portland General</li><li>• Puget Sound Energy</li></ul>

## Recommendations & Action Items

## Parties & Status

3) As opportunities arise to meet flexible capacity needs for Montana renewables, BPA should consider requests for providing products and services for integrating resources located outside the BPA balancing authority.

- BPA

4) Pacific Northwest utilities that may have an interest in acquiring Montana renewables should include scenarios with Montana renewables when studying their flexible capacity needs.

- Avista
- PacifiCorp
- Portland General
- Puget Sound Energy

5) BPA and NorthWestern Energy should seek a negotiated solution to the 184 MW transmission capacity dispute as soon as possible.

- **BPA**
  - **NorthWestern**
- Completed June 18, 2018**

6) BPA should hold a pre-rate case workshop discussion on alternatives for the Montana Intertie rate.

- BPA and stakeholders
- Stakeholders to bring proposals to pre-rate case workshops, which are scheduled bi-weekly through the summer of 2018.

7) Avista, BPA, NorthWestern Energy, and transmission customers should work together to evaluate possible comparable changes to transmission tariffs and business practices that may be impediments to exporting Montana renewables.

- Absaroka
- Avista
- BPA
- NorthWestern (Lead)
- Orion
- Renewable NW
- Other interested parties

8) For service on the existing BPA network, BPA should evaluate the feasibility and business case for offering conditional firm service for Montana exports, especially as a bridge product to long-term firm on its external interconnections.

- BPA
- In progress; to be completed by December 1, 2018

9) BPA should consider modifying its tariff terms and conditions to allow for developer-funded National Environmental Policy Act (NEPA) costs to be re-funded if long-term firm service is ultimately purchased at rolled-in embedded cost rates. This would be consistent with how environmental and permitting costs are treated by other transmission providers under the Federal Energy Regulatory Commission's "greater of" pricing policy.

- BPA
- In progress; to be completed by December 1, 2018

10) BPA should complete its determination that resource movement in only one direction within an operating hour does not consume DTC.

- **BPA**
- Completed March 6, 2018**

## Recommendations & Action Items

## Parties & Status

11) BPA should implement a new business practice and required systems to operationalize its DTC decision.

- BPA
- To be completed by  
June 1, 2021

12) BPA should modify its existing business practice to specify the current Garrison interchange DTC limit as is currently done for the southern intertie and the northern intertie.

- BPA
- To be completed by  
September 1, 2018

13) BPA should undertake actions to increase available transfer capacity on the BPA network in order to allow imports from Montana to reach I-5 load centers.

- a) Consider administrative changes resulting in additional ATC availability
- b) Consider flexible, scalable options to meet service requests across network flowgates:
  - i. Non-wires
  - ii. Planning re-dispatch
  - iii. Battery storage
  - iv. Demand-side management

- BPA
- Commercial assessment: To be completed in third quarter, 2018  
Corresponding cluster studies: To be completed in first quarter, 2019

14) Studies must be done in a formal interconnection process when specific generators are identified to include:

- a) Local voltage control
- b) Sub-synchronous resonance
- c) RAS design

- NorthWestern Energy

15) A scope of work should be developed to guide the studies needed should a future retirement or an unexpected, sustained outage of Colstrip units 3 and 4 occur.

**Planning Subcommittee  
Completed April 27, 2018**

16) NorthWestern, with support from the other Colstrip Owners and BPA, should undertake timely blackstart, sub-synchronous resonance mitigation, RAS, and WECC (Western Electricity Coordinating Council) Path Rating requirements when specific replacement generation for Colstrip unit retirement is identified and the technical attributes are known.

- BPA
- Colstrip Owners
- NorthWestern Energy (lead)

## Recommendations & Action Items

## Parties & Status

17) Studies should be completed using actual Montana wind data to confirm the diversity characteristics and balancing reserve requirements of new Montana wind resources.

- BPA

In progress; to be complete September 30, 2018.

18) NorthWestern's studies should be finalized that identify:

- a) Regulation and load following needs for existing wind resources; and,
- b) Regulation and load following needs for additional wind and solar resources.

- NorthWestern Energy

In progress; to be complete by July 31, 2018.

19) The viability of utilizing Colstrip units in condensing mode as well as the Gordon Butte pumped storage facility to provide voltage support, inertia, and frequency response should be studied as appropriate.

- Absaroka Energy (pumped storage)
- NorthWestern Energy (lead)

## Next steps

The subcommittees and steering committee concluded their formal work with the issuance of this report. To ensure that action items continue to move forward, BPA will track and responsible parties will report out on the items every three months via email. BPA and the State of Montana will sponsor a webinar for the steering committee and interested parties every six months as long as it is useful.

# Appendix

The appendix contains reports of each of the subcommittees that contain questions or reflect unknowns some of which have subsequently been resolved. The findings and recommendations found above reflect those resolutions.

## Commercial Policy Subcommittee details

### Significant Findings:

1. Advocates for Montana renewables (state government, developers and public interest groups) are “pushing” the export of Montana renewables. There needs to be a corresponding interest from potential purchasers “pulling” for the acquisition of Montana renewables.
2. The delivered cost of Montana wind resources to Pacific Northwest utilities appears to be competitive with other renewable resources. However, uncertainties about transmission and integration services are impediments to securing contracts for Montana wind resources.
3. There is (or will soon be) a significant amount of transmission capacity – from existing available capacity, the planned retirement of Colstrip units 1 and 2, and relatively low-cost (as compared with linear projects) upgrades) – to support development of a substantial quantity of Montana renewables for export to the Pacific Northwest, but not necessarily all the way to the Interstate-5 load centers.<sup>1</sup>

### Available Transmission Capacity for Montana Exports -2019<sup>2</sup>

	East of Garrison	West of Garrison	West of Hatwai	Cross Cascades
NWE to AVA to Mid-C	297	360	360	0
NWE to BPA	246	0	0	0
Montana Intertie	184	0	0	0
Total	727	360	360	0

<sup>1</sup> See Appendix E for additional TTC/ATC details

<sup>2</sup> The ATC in this table is for informational purposes only and compiled from publicly available sources.

**Potential incremental additions to transmission capacity for Montana exports  
post-2022<sup>3</sup>**

	East of Garrison	West of Garrison	West of Hatwai	Cross Cascades
BPA RAS Upgrade	0	200	200	0
PSE Colstrip 1&2 <sup>4</sup>	300	300	300	300
Montana-to-Washington Project	0	600	550	0
Colstrip Transmission Upgrade	800	0	0	0
<b>Total Incremental</b>	<b>1,100</b>	<b>1,100</b>	<b>1,050</b>	<b>300</b>
<b>Total with Existing ATC</b>	<b>1,827</b>	<b>1,460</b>	<b>1,410</b>	<b>300</b>

4. There is substantial uncertainty about the future status of Colstrip Units 3 and 4 in terms of when those units might be removed from service. The Planning Subcommittee's assessment is that the existing transfer capability of the Colstrip Transmission System can, with relatively minor reinforcements (as compared with linear projects), support a one-for-one replacement of Colstrip generation with new resources, including variable energy resources. See the Planning Committee report for additional details.
5. Results from the Operations Subcommittee indicate that a significant amount of dynamic transfer capability (DTC) is available to support development of a substantial quantity of Montana wind for export to the Pacific Northwest. DTC is necessary for compliance with the current Washington state renewable portfolio standard and enables options for integrating (balancing/regulating) Montana wind in Pacific Northwest balancing authorities. See the Operations Committee report for additional details.
6. Many of the transmission and integration challenges faced by Montana developers could be mitigated by the development of a Pacific Northwest regional transmission organization. However, formation of a regional transmission organization is a complex endeavor with potentially significant cost and governance issues<sup>5</sup>.
7. The Montana Intertie Agreement (MIA), originally conceived and written to move Colstrip generation to loads, has provisions that may need to be modified to facilitate future use of capacity on the BPA Eastern Intertie and the Colstrip Transmission System. BPA and the CTS parties agree that:
  - a. CTS parties can use their existing capacity rights under the MIA to move power they acquire other than Colstrip power.
  - b. Some modification to the MIA is required to provide for third-party wheeling.

<sup>3</sup> The ATC in this table is for informational purposes only and compiled from publicly available sources.

<sup>4</sup> PSE's available transmission on the Colstrip Transmission System is managed by PSE's transmission function and posted on OASIS. Transmission rights on the BPA network west of Garrison are contracted and managed by PSE's merchant function and can be reassigned or redirected. The 300 MW from Colstrip to PSE's balancing authority area in 2022 is not reflective of the ATC currently posted on OASIS.

<sup>5</sup> See Appendix G for additional details



## Appendix A

8. State elected officials and regulators have authority to establish policies regarding the selection of resources used to serve electric consumers in their jurisdictions. While recognizing state prerogatives in setting policies, state renewable portfolio standards should consider the impacts of additional eligibility requirements on out-of-state renewable resources.

## Recommendations:

1. BPA and the Colstrip Transmission System (CTS) owners should review the Montana Intertie Agreement (MIA) and the CTS Agreement and make modifications, if and as necessary, to facilitate future utilization of the Montana Intertie and CTS based on non-discriminatory, open access principles. Modifications should be made as soon as possible in consideration of expiring Production Tax Credits (PTC). This includes:
  - a. Addressing third-party and non-Colstrip use.
  - b. Reviewing the appropriateness of the CTS and MIA loss rates for third-party use.
2. Developers of Montana renewable projects should present credible and executable transmission plans to potential purchasers. Purchasers considering Montana renewables should allow a reasonable period after a resource is identified for acquisition to work with the developer to execute the transmission plan.
3. As opportunities arise to meet flexible capacity needs for Montana renewables, BPA should consider requests for providing products and services for resources located outside the BPA balancing authority.
4. Pacific Northwest utilities that may have an interest in acquiring Montana renewables should include scenarios with Montana renewables when studying their flexible capacity needs.
5. BPA and NorthWestern Energy (NWE) should seek a negotiated solution to the 184 MW transmission capacity dispute as soon as possible.
6. BPA should hold a pre-rate case workshop discussion on alternatives for the Montana Intertie rate.
7. Avista, BPA, NorthWestern Energy, and transmission customers should work together to evaluate possible changes to transmission tariffs and business practices that may be impediments to exporting Montana renewables.
8. BPA should evaluate the feasibility and business case for offering Conditional Firm service for Montana exports.
9. BPA should consider modifying its current policy to allow for developer-funded National Environmental Protection Act (NEPA) costs to be refunded if long-term firm (LTF) service is ultimately purchased at rolled-in embedded cost rates. This would be consistent with how environmental and permitting costs are treated by other transmission providers under FERC's "greater of" pricing policy.

## Available Transmission Capacity

### Inventory

This subcommittee was tasked with examining the current inventory of available transfer capability (ATC) on the transmission systems of the various entities in Montana including NorthWestern Energy, the Colstrip Parties, Avista and BPA from the point of resource integration to the points of receipt (Colstrip to Garrison, West of Garrison, West of Hatwai, and beyond to western load centers). In addition, the subcommittee was tasked with examining the current ATC to the east, north and south out of Montana.

While inventories to the east, north, and south are identified below, there was consensus from the subcommittee and support from the Steering Committee to prioritize efforts on markets in the Pacific Northwest.

Firm ATC for 2018*			
Path 8	Export	146**	to BPA
	Import	215***	from BPA
	Export	297	to Avista (AVA)
	Import	381***	from AVA
	Export	49	to Montana Intertie (MI) at Townsend
Path 18	Export	6	Brady, Jeff (PacifiCorp, or PAC)
	Import	131	Brady, Jeff (PAC)
Path 80	Export	600	Yellowtail, Crossover (PAC)
	Import	290	Yellowtail, Crossover (PAC)
Path 83	Export	47	Montana Alberta Transmission Line (MATL)
	Import	170	MATL

\* Note these numbers may change at any time depending on market conditions

\*\*Increases to 246 MW on January 1, 2019.

\*\*\*Imports from Avista transmission (AVAT) and BPA transmission (BPAT) bottle neck with an ATC of 395 MW

There is a significant amount of existing ATC from Montana to the west, although there are constraints on the BPA network further west before reaching Pacific Northwest load centers. Today NorthWestern Energy (NWE) can deliver 297 MW to Avista (AVA) and 146 MW to BPA (246 MW effective 1/1/19). In addition, there is another 184 MW that can be delivered west across the Montana Intertie 500 kV system for a total of 297 MW to AVA and 330 MW (430 MW effective 1/1/19) to BPA. Furthermore, today AVA has ATC to move the 360 MW of power imported from NWE to the Mid-Columbia Public Utility Districts (PUDs).<sup>6</sup>

In 2022 with the closure of Colstrip Units 1 and 2, potential transmission capacity to the BPA Network would be 730 MW<sup>7</sup> with an additional 500 MW<sup>8</sup> potentially on the BPA Network across West of Garrison (WOG) and West of Hatwai (WOH). Moving power further west across the BPA network to I-5 load centers faces additional transmission challenges which are being addressed by BPA. BPA is also considering upgrades (Remedial Action Schemes (RAS), Montana to Washington (M2W), and Garrison Ashe project (GASH)) on its Network via the Transmission Service Request Study and Expansion Process (TSEP) to increase capacity on the BPA Network across WOG and WOH. Additional ATC details can be found in Appendix E.

**Available Transmission Capacity for Montana Exports - 2019**

	East of Garrison	West of Garrison	West of Hatwai	Cross Cascades
NWE to AVA to Mid-C	297	360	360	0
NWE to BPA	246	0	0	0
Montana Intertie	184	0	0	0
Total	727	360	360	0

<sup>6</sup> For informational purposes only, compiled from publicly available sources.

<sup>7</sup> Reflects 300 MW of PSE merchant rights on the MI that PSE controls.

<sup>8</sup> Reflects 300 MW of PSE merchant rights on the BPA Network under OATT service that PSE controls, and 200 MW increase with implementation of MT RAS and LTF sales on WOG increased to 1,818 MW.

### To Potential Transmission Capacity for Montana Exports - 2022

	East of Garrison	West of Garrison	West of Hatwai	Cross Cascades
BPA RAS Upgrade	0	200	200	0
PSE Colstrip 1&2 <sup>9</sup>	300	300	300	300
Montana-to-Washington Project	0	600	550	0
Colstrip Transmission Upgrade	800	0	0	0
<b>Total Incremental</b>	<b>1,100</b>	<b>1,100</b>	<b>1,050</b>	<b>300</b>
<b>Total with Existing ATC</b>	<b>1,827</b>	<b>1,460</b>	<b>1,410</b>	<b>300</b>

**What is the impact of pancaked rates (including losses and scheduling and dispatch charges) on the total transmission cost to reach Pacific Northwest markets?**

Transmission Systems	Trans Rate (\$/kw-mo)	Losses	Total Cost* (\$/MWh)
<b>BPA</b>	\$1.79	1.9%	\$6.02
PSE CTS + MT Int + BPA	\$4.95	4.6%**	\$16.45
NWE + BPA	\$5.12	5.9%	\$17.36
NWE + AVA	\$5.33	7.0%	\$18.33
NWE + AVA + BPA	\$7.12	8.9%	\$24.34

\* Total cost based on 45% capacity factor and losses valued at \$30/MWh

\*\* Does not include 5% MT Intertie losses for third party use

<sup>9</sup> PSE's available transmission on the Colstrip Transmission System is managed by PSE's transmission function and posted on OASIS. Transmission rights on the BPA network west of Garrison to PSE's load center are contracted and managed by PSE's merchant function and can be reassigned or redirected. The 300 MW from Colstrip to PSE's balancing authority area in 2022 is not reflective of the ATC currently posted on OASIS.

Appendix A

The remainder of Appendix A does not represent a complete work product nor a full consensus on the evaluation of pros and cons of the identified alternatives.

**Markets**

**Has Montana wind been identified as an attractive resource by potential purchasers in Montana, other Pacific Northwest states and California?**

<b><u>Washington IOUs:</u></b>	<b><u>Oregon IOUs:</u></b>	<b><u>California:</u></b>
Puget Sound Energy (PSE) 2017 IRP selected Washington solar (assuming no BPA transmission costs) over Montana wind (with CTS and MI sunk costs treated as incremental), but indicated that “the results are close” and should be tested by a Request for Proposal (RFP) in 2018.	Portland General Electric (PGE) 2016 IRP found that Montana wind would be competitive with Pacific Northwest wind assuming levelized transmission costs of \$65/kw-year. PGE plans an RFP in 2018.	Difficult to access California due to transmission constraints and market rules.
<b><u>NW Public Power:</u></b>	<b><u>Montana Public Power:</u></b>	<b><u>Montana “Choice” Customers:</u></b>
Limited interest in near term, but interest may grow in anticipation of BPA contracts expiring in 2028.	Limited interest in near term, but Western Montana co-ops interested in new power sources in anticipation of BPA contracts expiring in 2028.	Difficult for new renewables to compete with near-term wholesale market prices.

**What are the impacts of the Production Tax Credit (PTC) phase-out on competitiveness of Montana wind?**

<b><u>Scenario 1:</u></b>
Phase out of PTCs makes wind more attractive in near term which should incentivize near term procurement by utilities. Following elimination of PTCs, Montana wind will still be competitive for meeting growing RPS requirements (50% in Oregon and California) and state clean energy goals (increased RPS or carbon tax in Washington).

**What are the requirements for integrating Montana wind to meet the Renewable Portfolio Standard (RPS) requirements of Washington, Oregon, and California?**

<u>Washington:</u>	<u>Oregon:</u>	<u>California:</u>
Montana renewables located outside the PNW must be “delivered into Washington state on a real-time basis without shaping, storage or integration services.”	None.	Generally, Montana wind must be delivered to California in real-time, but accounting rules allow the lesser of actual or scheduled generation integrated outside California to count toward the RPS.

**How might the Washington RPS integration requirements be met by Montana wind?**

<u>Alt #1:</u>	<u>Alt #2:</u>
Modify Washington RPS to eliminate special requirements for Montana renewables.	Identify dynamic transfer capability (DTC) to satisfy Washington RPS requirements.

**Introduction:** Montana renewables located outside the PNW must be “delivered into Washington state on a real-time basis without shaping, storage or integration services” to qualify for the Washington RPS. Dynamic Transfer Capability (DTC) satisfies this WA RPS requirement.

DTC is the amount of MW movement over a transmission path that can be accommodated in-hour without violating voltage limits and is used when resources are moving around in-hour. DTC may be limited and is allocated following BPA’s Business Practice.

**Alternative #1:**

**Description:** Modify Washington RPS to eliminate special requirements for Montana renewables.

**Pros**

- Eliminates requirement that discriminates against Montana renewable resources.

**Cons**

- Requires action by Washington state legislators or voters.

**Alternative #2:**

**Description:** Identify DTC to satisfy Washington RPS requirements.

**Pros**

- Investigation to date indicates there is significant DTC available on BPA and AVA.
- Does not require change in Washington law.

**Cons**

- Does not allow for use of Montana energy storage projects to add value to Montana renewables.

**RECOMMENDATION: None.**

**What are potential approaches to replacing Colstrip generation, especially Colstrip Units 3 and 4?**

<u>Alt #1:</u>	<u>Alt #2:</u>
Individual utilities secure replacement resources with no coordination	Utilities coordinate replacement efforts

**Introduction:** Standard practice for utilities is to procure new resources independently, with no coordination with other utilities. This approach may miss opportunities to jointly develop larger projects with significant scale economies. The retirement of Colstrip generation may provide a unique opportunity for some or all the Colstrip utilities to work together to develop an optimal replacement strategy.

**Alternative #1:**

**Description:** Individual utilities secure replacement resources with no coordination.

**Pros**

- Most straightforward approach for utilities.

**Cons**

- May miss optimal solution that requires scale to achieve economies.

**Alternative #2:**

**Description:** Utilities coordinate replacement efforts.

**Pros**

- May result in optimal solution that requires scale to achieve economies.

**Cons**

- More complex approach for utilities.
- May not be consistent with utilities' current competitive procurement processes.

**CONCLUSION: The Steering Committee and Sponsors' guidance was to eliminate this issue from the Project scope given the substantial uncertainty regarding the expected retirement of Colstrip Units 3 and 4.**



**Balancing/Regulation**

**What are the alternatives for integrating (balancing/regulating) Montana wind?**

<b><u>Alt #1:</u></b>	<b><u>Alt #2:</u></b>	<b><u>Alt #3:</u></b>
Host Balancing Authority Areas (BAA) - (NWE, WAPA, others)	BPA BAA	Sink BAAs (PSE, PGE, others)
<b><u>Alt #4:</u></b>	<b><u>Alt #5</u></b>	<b><u>Alt #6</u></b>
Generation-only BAAs (new, existing)	Montana energy storage – PSH Mechanical and Electrical Design Consultancy (PSH)	Other BAAs

**Introduction:** Several options are available for providing integration (balancing/regulating) services for Montana wind projects exported to the Pacific Northwest.

**Alternative #1:**

**Description:** NorthWestern Energy BAA

**Pros**

**Cons**

- May be expensive due to small size and limited diversity in NWE BAA.
- NWE not obligated to provide this service.
- Would not meet Washington RPS requirements.

**Alternative #2:**

**Description:** BPA BAA

**Pros**

- May provide opportunity for BPA to replace wind integration revenues as other wind projects exit BPA BAA.
- Diversity (lack of correlation) between Montana wind and other wind in BPA BAA.
- Meets Washington RPS requirements.

**Cons**

- Requires dynamic transfers into BPA BAA.
- Would require BPA policy change.

**Alternative #3:**

**Description:** Sink BAAs (PSE, PGE, others)

**Pros**

- Makes energy imbalance market (EIM) tools available.
- Diversity (lack of correlation) between Montana wind and other wind in sink BAAs or EIM.
- Meets Washington RPS requirements.

**Cons**

- Requires dynamic transfers into and out of BPA BAA.

**Alternative #4:**

**Description:** New Montana generation-only BAAs

**Pros**

- Can be pursued independently by developers.

**Cons**

- May be expensive due to small size and limited diversity in generation-only BAAs.
- Would not meet Washington RPS requirements.

**Alternative #5:**

**Description:** Montana energy storage (PSH)

**Pros**

- Could be combined with any of the other alternatives.
- Energy storage provides benefits beyond pure integration services (capacity, arbitrage, congestion management, system inertia, etc.)
- Gordon Butte PSH is construction-ready.

**Cons**

- Generally, energy storage adds most value as a flexible system resource as opposed to being limited to providing integration services for a specific renewable project.
- Would not meet Washington RPS requirements.

**RECCOMENDATION:** As opportunities arise to meet flexible capacity needs for Montana renewable resources, BPA should consider requests for providing products and services for resources located outside the BPA balancing authority.

**RECOMMENDATION:** Pacific Northwest utilities that may have an interest in acquiring Montana renewables should include scenarios with Montana renewables when studying their flexible capacity needs.

## **Transmission Capacity Availability**

### **How can the outstanding dispute between BPA and NorthWestern Energy over access to 184 MW of capacity on the Montana Intertie be resolved?**

**Introduction:** BPA and NWE agree there is 184 MW of ATC from Montana to BPA, however BPA and NWE disagree about who has the right to sell the 184 MW; BPA on the Montana Intertie or NWE on its underlying system. Both parties agree there is only 184 MW and both parties cannot sell the 184 MW. This dispute has gone on for several years and creates uncertainty for potential transmission customers looking for transmission capacity from Montana to markets to the west. This is a bilateral issue between BPA and NWE that impacts other parties. Since this Montana Renewables Development Action Plan (MRDAP) process started, there has been movement on this issue.

<b><u>Alt #1:</u></b>	<b><u>Alt #2:</u></b>
BPA & NWE good faith efforts to negotiate a solution	BPA & NWE good faith efforts to negotiate a solution, followed by binding dispute resolution process (FERC, arbitration)

#### **Alternative #1:**

**Description:** BPA and NWE demonstrate good faith efforts to negotiate a solution

##### **Pros**

- Process can be easily initiated.

##### **Cons**

- May not lead to a solution.

#### **Alternative #2:**

**Description:** BPA and NWE good faith efforts to negotiate a solution for 180 days, followed by binding dispute resolution process (FERC, arbitration)

##### **Pros**

- Leads to a definitive resolution.

##### **Cons**

- BPA and/or NWE may be unwilling to commit to binding dispute resolution.

**RECOMMENDATION:** BPA and NWE should seek a negotiated solution to the 184 MW transmission capacity dispute as soon as possible.

**Can BPA Conditional Firm Transmission Service (CF) be used to export Montana wind to Pacific Northwest markets?**

<u>Alt #1:</u>	<u>Alt #2:</u>
Status quo, CF only on internal BPA flowgates	BPA offer CF on WOG (and other external paths)

**Background:** BPA does not offer CF on External Interconnections (WOG, WOH) and/or Interties because the OATi Curtailment Wizard tool used to manage congestion at BPA’s borders does not curtail CF as currently designed. BPA is able to offer CF on Internal Flowgates and Paths since iCRS is used to manage congestion on the internal Network and it was designed to curtail CF.

**Alternative #1:**

**Description:** Status quo, CF only on internal BPA flowgates

**Pros**

- 

**Cons**

- No CF available for MT exports across WOG and WHO.

**Alternative #2:**

**Description:** BPA offer CF on WOG (and other external paths)

**Pros**

- Better utilization of existing system.
- Increased opportunity for PNW purchaser to acquire Montana renewables.

**Cons**

- May have limited value to purchasers.
- Time and cost to enable software changes.

**RECOMMENDATION: BPA should evaluate the feasibility and business case for offering Conditional Firm service for Montana exports.**

## **Montana Intertie and CTS Agreements**

### **How might existing transmission agreements be modified to free up future use of the Colstrip Transmission System?**

<b><u>Alt #1:</u></b>	<b><u>Alt #2:</u></b>	<b><u>Alt #3:</u></b>
BPA and Colstrip owners modify Montana Intertie Agreement to allow third party and non-Colstrip use	BPA and Colstrip owners convert all or a portion of their Montana Intertie capacity rights to Open Access Transmission Tariff (OATT) service	BPA and Colstrip owners modify the Montana Intertie capacity allocations to provide for BPA to market PSE’s unused capacity

**Introduction:** The Montana Intertie Agreement (MIA) was conceived to facilitate the transfer of power generated at the Colstrip power plants across the Colstrip Transmission System and the Montana Intertie, and to deliver that power across BPA’s Network to CTS owner’s loads (except MPC/NWE who deliver across BPA’s 500/230 transformer at Garrison Sub). The MIA does not provide for third-party usage and may be interpreted by some to not allow for transfers of power not generated at Colstrip. The 1981, six-party Agreement is complicated, was written for a particular purpose, was written before Federal Energy Regulatory Commission (FERC) Order 888, and is set to expire in 2027.

See Appendix F for additional discussion pertaining to the Montana Intertie Agreement.

### **Alternative #1:**

**Description:** BPA and Colstrip owners modify Montana Intertie Agreement to allow third-party and non-Colstrip use.

### **Pros**

- Process can be easily initiated.
- MIA parties appear to support these proposed modifications.
- Process could be expanded to address other issues (5% third-party losses?).

### **Cons**

- Multi-party negotiations can take extended time.
- Parties may want to include extraneous issues in the negotiations.

**Alternative #2:**

**Description:** BPA and Colstrip owners convert all or a portion of their Montana Intertie capacity rights to open access transmission tariff (OATT) service.

**Pros**

- Updates the contract to standard OATT service.
- Provides for third-party wheeling.
- Provides for more accurate scheduling.

**Cons**

- Must address stranded cost provisions

**Alternative #3:**

**Description:** BPA and Colstrip owners modify MI capacity allocations to provide for BPA to market PSE’s unused capacity.

**Pros**

- Facilitates use of unneeded capacity.
- Avoids prolonged process to amend the agreement.

**Cons**

- Must ensure revenue neutrality.

**RECOMMENDATION:** BPA and the Colstrip Transmission System (CTS) owners should review the Montana Intertie Agreement (MIA) and the CTS Agreement and make modifications, if and as necessary, to facilitate future utilization of the MI and CTS based on non-discriminatory, open access principles. This includes:

- a. Addressing third-party and non-Colstrip use.
- b. Reviewing the appropriateness of the CTS and MIA 5% loss rates for third party use.

**How should third-party transmission losses be addressed under the MIA?**

<b><u>Alt #1:</u></b>	<b><u>Alt #2:</u></b>
Status quo, maintain 5% loss rate for third-party transactions	Eliminate special 5% loss rate and treat third-party transactions the same as other CTS/MI transfers in the loss calculations.

**Introduction:** The Montana Intertie Agreement includes detailed provisions for the calculation of losses on the CTS and MI. The calculated losses are generally in the range of 3%. However, the MIA includes a higher loss rate of 5% for third-party transactions.

Appendix A

**Alternative #1:**

**Description:** Status quo, maintain 5% loss rate for third-party transactions

**Pros**

- No action required.

**Cons**

- Perpetuates loss rate that discriminates against third-party users.

**Alternative #1:**

**Description:** Eliminate special 5% loss rate and treat third-party transactions the same as other CTS/MI transfers in the loss calculations.

**Pros**

- Eliminates loss rate that discriminates against third-party users.
- Could be added as part of MI Agreement renegotiations.

**Cons**

- Requires modification of MI Agreement.

**RECOMMENDATION:** See previous recommendation on the MIA.

**Montana Intertie Rates**

**What are the options for the future of the Montana Intertie (IM) rate?**

<b><u>Alt #1:</u></b>	<b><u>Alt #2:</u></b>	<b><u>Alt #3:</u></b>	<b><u>Alt #4</u></b>	<b><u>Alt #5:</u></b>
Eliminate IM pancaked transmission (\$0.509/kw-mo), scheduling (\$0.322/kw-mo) in future BPA rate case	Eliminate IM pancaked scheduling (\$0.322/kw-mo) in future BPA rate case	Comprehensive redesign of the IM rate	Auction unsubscribed capacity	Status Quo

**Introduction:** The IM rate applies to BPA’s 200-MW portion of the 1,930 MW capacity Townsend-to-Garrison segment, known as the Eastern Intertie (EI). The EI has gone unsubscribed for a number of

## Appendix A

years due to lack of demand, with the exception of 16 MW that has been subscribed for several years by one of the Colstrip owners.

Virtually any revenue that BPA receives for this existing capacity would exceed its marginal cost. While utility regulators must also consider the necessity of covering the embedded costs of such transmission investment in ratemaking, here a contractual provision exists to cover all of the EI's revenue requirement through the Montana Intertie Agreement.

Eliminating the pancaked rate for the EI has been argued unsuccessfully in multiple BPA rate cases. In the last BPA rate case, the rate was reduced by 15%, and the issue was cited by the Administrator as an impetus for the present initiative.

The appropriate forum for any future changes to Montana Intertie rates is the BPA rate case. However, it is the mandate of this group to propose recommendations that might assist that resolution, and each party that participated in the previous rate case has had notice of and an opportunity to participate in the work of this group.

### **Alternative #1:**

**Description:** Eliminate MI pancaked transmission (\$0.509/kw-mo), scheduling (\$0.322/kw-mo) in future BPA rate case.

#### **Pros**

- Would provide greatest relief for potential MI customers.
- Aligns with the principle that rates should reflect the marginal cost of existing unsubscribed capacity, in order to maximize the full usage of the existing system.

#### **Cons**

- Eliminating pancaked MI rate has been unsuccessfully argued in the past.

### **Alternative #2:**

**Description:** Eliminate MI pancaked scheduling (\$0.322/kw-mo) in future BPA rate case.

#### **Pros**

- Provides possible middle ground, reduces the overall cost by nearly 40%.
- Past arguments have been focused on the MI transmission rate, not on scheduling charge.

#### **Cons**

- Pancaked scheduling charge may be susceptible to same opposition arguments as transmission rate (i.e., possible precedent for Southern Intertie).



**Alternative #3:**

**Description:** Comprehensive redesign of the MI rate.

**Pros**

- Could allow for creative solutions.

**Cons**

- May be susceptible to historic cost shifting arguments.

**Alternative #4:**

**Description:** Auction the unsubscribed capacity.

**Pros**

- Does not set the rate at marginal cost, as Alternative #1 does, but instead measures the market value of the unsubscribed capacity.
- Would keep BPA whole, because any shortfall between auction proceeds and revenue requirement would be contractually made up by signatories to the 1981 (amended in 1994) agreement.
- Proceeds of the auction would be credited to the revenue requirement, and would relieve the Colstrip parties from the burden of having to pay the full embedded cost of capacity that continually goes unsubscribed.

**Cons**

- Lack of precedent.
- Ability to do so under the OATT.

**Alternative #5:**

**Description:** Status Quo

**Pros**

- No action required.

**Cons**

- Greatest cost for potential MI customers.

**RECOMMENDATION:** BPA should hold a pre-rate case workshop discussion on alternatives for the Montana Intertie rate.

**Transmission Tariff and Business Practices**

**What are potential solutions to coordinating timing of power sales and transmission contracts?**

<u>Alt #1:</u>	<u>Alt #2:</u>	<u>Alt #3:</u>
Developers contract for transmission in advance of securing power contacts	Developers secure power contracts, then finalize arrangements for transmission service	Coordinated effort between utility resource procurement and developers

**Introduction:** Coordinating the timing of power sales and transmission contracts is a significant barrier to the successful development of large-scale Montana wind projects.

**Alternative #1:**

**Description:** Developers contract for transmission in advance of securing power contacts.

**Pros**

**Cons**

- Too expensive/risky for developers to commit to take-or-pay transmission contracts prior to power sales or build-own-transfer agreements.

**Alternative #2:**

**Description:** Developers secure power contracts, and then finalize arrangements for transmission service.

**Pros**

- Shares transmission risk between developers and purchasers.

**Cons**

- Must be able to demonstrate clear path to addressing transmission issues to secure power sales or build-own-transfer agreements.

**Alternative #3:**

**Description:** Coordinated effort between utility resource procurement and developers.

**Pros**

- Coordinated effort is appropriate for addressing major investments with long lead times.

**Cons**

- May not be consistent with utilities’ current competitive procurement processes.

**RECOMMENDATION: Developers of Montana renewable projects should present credible and executable transmission plans to potential purchasers. Purchasers considering Montana renewables should allow a reasonable period after a resource is identified for acquisition to work with the developer to execute the transmission plan.**

**If multiple Transmission Operators (TOs) need to make investments on their systems to provide additional transmission capacity, what opportunity is there for a joint tariff or coordinated transmission offering? Are there opportunities to synchronize Transmission Provider (TP) processes for a requestor? What are they?**

<b><u>Alt #1:</u></b>	<b><u>Alt #2:</u></b>	<b><u>Alt #3:</u></b>
Regional tariff	Regional queue with individual TP tariffs	Service Across Multiple Transmission Systems (SAMTS)

**Introduction:** Balkanized transmission grid ownership and tariffs make it difficult for transmission customers to coordinate transmission service requests across multiple transmission systems and places significant financial risk on developers.

See Appendix G for discussion on how a regional transmission organization could be useful in addressing this and other transmission and ancillary service issues.

**Alternative #1:**

**Description:** Regional tariff

**Pros**

- Most robust solution.

**Cons**

- Very heavy lift given regional history (even without other Regional Transmission Organization, or RTO, functions).

**Alternative #2:**

**Description:** Regional queue with individual TP tariffs

**Pros**

- May meet with less regional resistance.

**Cons**

- Complex to negotiate and mesh with individual TP tariffs.

**Alternative #3:**

**Description:** Service Across Multiple Transmission Systems (SAMTS)

**Pros**

- Established BPA and North American Energy Standards Board (NAESB) business practices.
- Narrower fix than regional tariff or regional queue.

**Cons**

- Could result in stagnation of TP queues.
- Would require TPs to develop/adopt SAMTS business practices.

**RECOMMENDATION: Avista, BPA, NorthWestern, and transmission customers should work together to evaluate possible changes to transmission tariffs and business practices that may be impediments to exporting Montana renewables.**

**How should cost allocation and transmission rate treatment be determined for the incremental ‘tranches’ of investment?**

<b><u>Alt #1:</u></b>
Current FERC and BPA policies – greater of embedded or incremental

**Introduction:** FERC has well-established policies for allocating the cost of upgrades. Generally, the transmission customer causing the upgrades pays the greater of the transmission provider’s embedded cost tariff rate or an incremental rate based on the cost of the upgrades. BPA generally follows the FERC policy, but has proposed charging the embedded cost rate in some instances where the incremental upgrade rate would slightly exceed the embedded cost rate.

**Alternative #1:**

**Description:** Current FERC and BPA policies – greater of embedded or incremental cost rate.

**Pros**

- Well-established policy with strong precedents.

**Cons**

**How should environmental study costs for NEPA associated with potential upgrades on BPA’s system be funded?**

<b><u>Alt #1:</u></b>	<b><u>Alt #2:</u></b>	<b><u>Alt #3</u></b>	<b><u>Alt #4</u></b>
BPA pays for NEPA costs	Customer pays for NEPA costs	Customer pays for NEPA costs and get reimbursed or provided Network Transmission Credits if they take LTF service over these facilities at embedded rates	State of Montana forms an Infrastructure Authority to fund these costs

**Alternative #1:**

**Description:** BPA pays for NEPA costs.

**Pros**

- Least cost/risk for developers.

**Cons**

- Greatest cost/risk for BPA.

**Alternative #2:**

**Description:** Customer pays for NEPA costs.

**Pros**

- Least cost/risk for BPA.

**Cons**

- Greatest cost/risk for developers.

**Alternative #3:**

**Description:** Customer pays for NEPA costs and gets reimbursed or provided Network Transmission Credits if they take long-term firm service over these facilities at embedded rates.

**Pros**

- Possible middle ground.
- Consistent with FERC “greater of” cost principle.

**Cons**

**Alternative #4:**

**Description:** State of Montana forms an Infrastructure Authority to fund these costs.

**Pros**

**Cons**

- Likely non-starter given Montana state budget situation.

**RECOMMENDATION:** BPA should consider modifying its current policy to allow for developer-funded NEPA costs to be refunded if long-term firm (LTF) service is ultimately purchased at rolled-in embedded cost rates. This would be consistent with how environmental and permitting costs are treated by other transmission providers under FERC’s “greater of” pricing policy.

**Are there other various BPA Tariff, OATT, Business Practice and FERC issues?**

<b><u>Issue 1:</u></b>	<b><u>Issue 2:</u></b>	<b><u>Issue 3:</u></b>
5-year take or pay commitment	Must take (and pay for) ATC to get upgrade studies	No redirects for Transmission Service Requests (TSRs)
<b><u>Issue 4:</u></b>	<b><u>Issue 5:</u></b>	
BPA Mid-C PUD vs. sink	Priority for MT? service	

**RECOMMENDATION:** Avista, BPA, NorthWestern Energy and transmission customers should work together to evaluate possible changes to transmission tariffs and business practices that may be impediments to exporting Montana renewables.

**What approaches are available for developing an efficient “collector system” to deliver Montana wind into “backbone” transmission for exports?**

<u>Alt #1:</u>	<u>Alt #2:</u>	<u>Alt #3:</u>
NorthWestern Energy responds to requests and builds facilities as needed	Developers construct generation tie lines to meet individual needs	Coordinated stakeholder process that takes a long-term look at resources to develop an efficient plan

**Introduction:** Much attention has been focused on “repurposing” the CTS and MI when the Colstrip generation is retired. There may be various alternatives for connecting new wind projects with the CTS.

**Alternative #1:**

**Description:** NorthWestern Energy responds to requests and builds facilities as needed

**Pros**

- NWE is an experienced and capable transmission provider.
- New transmission would be integrated into the existing network.

**Cons**

- May not be least-cost option for developers.

**Alternative #2:**

**Description:** Developers construct generation tie lines to meet individual needs.

**Pros**

- Can be pursued independently by developers.
- May be lower cost than having NorthWestern construct.

**Cons**

- Radial generation ties not integrated into existing network.

**Alternative #3:**

**Description:** Coordinated stakeholder process that takes a long-term look at resources to develop an efficient plan.

**Pros**

- Could result in optimal solution.

**Cons**

- Unclear how this would fit with tariffs and ultimate obligation to build.
- Would require large coordinated effort and long-term vision.

## Planning Subcommittee details

The Planning Subcommittee updated potential capital projects and the impact they would have on Available Transfer Capacity. It also reviewed and refreshed existing studies regarding the Colstrip Transmission System to determine the impact of unit retirement on the transmission capacity. Finally, the timing of studies required to confirm Path 8's (Montana to the Northwest) rating and performing other regional reliability processes following the change in system topology associated with the Colstrip unit retirement were determined.

### Montana to Washington and Colstrip Transmission Upgrade

BPA and the MRDAP Planning Subcommittee have updated the expected cost and timing for both the Montana to Washington (M2W) and the Colstrip Transmission (CTS) upgrades. Information about the history, design, and context for how these two projects relate to the current options for increased transmission access out of Montana are also provided below.

### Colstrip Transmission Upgrade

Avista (AVA), NorthWestern Energy (NWE), and the Bonneville Power Administration (BPA) performed joint studies in the 2000s to identify a set of feasible transmission reinforcements that might enable the Transmission Owners to increase the transfer capability of the system between Montana and the Pacific Northwest. Those studies identified a series of facilities as follows:

- Additions to series compensation of the 500 kV system between Colstrip and the Pacific Northwest between Broadview in Montana and Coulee and Hatwai substations in Washington.
- Several line upgrades on the BPA network.
- Line upgrades, transformer upgrades, and continued operation of the “star” network on the AVA system.
- Mitigation to the Colstrip generation from changes in Sub-Synchronous Resonance (SSR) due to the series compensation changes on the 500 kV system.
- Participation in Remedial Action Scheme(s) (RAS) from resources that would require access to the incremental capacity.

Estimated costs taken from the June 2012 report:

- BPA transmission system: \$126.7 million
- Colstrip Transmission System: \$87 million
- Avista transmission system: \$38 million

Below is a summary of the status of the various components of the CTS upgrade:

- Significant reinforcements on the Avista system have been completed:
  - Westside 230/115 kV autotransformer upgrades and associated equipment.
  - Loop Boulder-Rathdrum 230 kV line into Lancaster Substation.



## Appendix B

- Maintain present “Star Network” configuration on the Avista 115 kV system in the Big Bend area. The Star Network configuration (i.e. open 115 kV lines) should be maintained unless definitive studies show that these lines can be closed.
  - Complete 115 kV reconductoring project (~ 37.4 miles) from Cabinet Gorge to Sandpoint.
  - Avista’s new Moscow 230/115 kV transformer in service and associated 115 kV reconductoring to include Turner substation (located in Pullman, WA).
- 
- SSR studies have been completed which identified the mitigation for Colstrip generation assuming all four units would be in service. Additional studies would be needed to address retirement of units 1 and 2. These costs would be incremental to the \$214 M identified above for the BPA transmission system plus the Colstrip Transmission System.
  - No further project development of series compensation east of Garrison substation has taken place.
  - Neither cost allocation nor capacity allocation has taken place for capacity east of Garrison (between and Transmission Owners, including CTS owners).
  - No capacity allocation has occurred for capacity within the Pacific Northwest (AVA and BPA).

### **Montana to Washington Upgrade Project (M2W)**

BPA initiated a project on its network following the 2010 Network Open Season (and further informed in the 2013 Network Open Season) that became known as M2W. The project addressed transmission requirements on the BPA network only. It did not address facilities on the AVA system, nor on any 500 kV facilities east of BPA’s Garrison 500 kV substation (nor costs to mitigate the SSR for the Colstrip generation).

BPA initiated a National Environment Policy Act (NEPA) and preliminary engineering effort for the project. In 2014, BPA discontinued the NEPA and preliminary engineering for the project when requests for transmission service to support the project discontinued their participation.

In the 2016 Transmission Service Request Study and Expansion Process (TSEP), there were again a significant number of requestors that would need access to the capacity from the M2W project. BPA is in the process of again proceeding with a NEPA and preliminary engineering effort to determine whether to proceed with development of the M2W project.

The M2W project refers to upgrades on the BPA Network - facilities west of BPA’s Garrison Substation plus BPA’s share of harmonic filtering at the Colstrip Generating Station:

- The project would involve upgrades at five existing BPA substations (Garrison and Hot Springs Substations in Montana, Dworshak and Hatwai Substations in Idaho, and Bell Substation in Washington).
- Replacement of about 11.4 miles of electrical wire (conductor) along portions of BPA's existing Dworshak-Taft transmission line.

## Appendix B

- Improvements to about 25 miles of existing access roads.
- Construction of a new substation in Montana. The proposed new substation would be constructed along the BPA's existing Garrison-Taft transmission line.
- Direct costs: \$119 M; energization post 2023 (optimistic).

It is important to reinforce that the M2W project only addresses the needs on the BPA system.

In the context of Colstrip Units 1 and 2 retiring, the urgency of the M2W and CTS capacity upgrades may be declining. When additional capacity is required west of Garrison, M2W provides a low-cost low-impact option compared to additional linear facilities. When additional capacity west of Colstrip is required, the CTS upgrades provide a similar low-cost low-impact option.

Sub-Synchronous Resonance (SSR):

The SSR impacts referred to in the CTS and M2W project discussion above warrant additional comment. Changes to the 500 kV transmission facilities, either by modification of series compensation on those lines or through addition of new interconnecting substations that change the transmission line configurations could impact the design of the SSR filters that are in place. The required SSR configuration is, and will continue to be, a normal consideration of maintaining the reliability of the transmission system.

Filters can be added to modern wind machines to block them from producing undesirable frequencies associated with SSR.

### **Maintaining Reliable CTS Operations and Path Limits Under Multiple Resource Futures:**

The Planning Subcommittee has reviewed four transmission studies and one white paper analyzing various Colstrip Unit 1-4 operating scenarios.<sup>10</sup> In general, these four studies have not surfaced any insurmountable barriers to the concept of maintaining the reliable operation of the Colstrip Transmission System to support significant exports of Montana wind energy. All of the studies rely on several assumptions and the results must be confirmed when new generation is specified. A fuller summary of each study and its underlying assumptions is provided in Appendix H. The Subcommittee also identified additional study work that will be necessary under certain future scenarios. At the time of writing, NorthWestern Energy (NWE) is also conducting a study to confirm the carrying capability of the CTS after Colstrip Units 1 and 2 retire. NWE is performing this study per the request of Puget Sound Energy. The scope of the study includes three main sections: a confirmation of the 2200 MW path rating for west-bound Path 8 flows with all four Colstrip units in service, an analysis to determine if 2200 MW west-bound on Path 8 is achievable without Colstrip units 1 and 2, with the use of replacement generation and adjustment of phase shifting transformers, and an analysis focusing

---

<sup>10</sup> See Appendix H:  
[2014-2015, Public Policy Consideration Study for NTTG:](#)  
[2016-2017, Public Policy Consideration Study for NTTG](#)  
[NWE sponsored study, retirement of CS units 1 and 2](#)  
[NWE sponsored study, retirement of all coal in NWE's BA](#)  
[RNW sponsored whitepaper by Chuck Stigers:](#)

primarily on the 500 kV system assuming no Colstrip units 1 and 2, without replacing any lost generation or allowing phase shifters to move. The study work is expected to be available in July 2018.

The studies performed to date, along with the review and discussions by the MRDAP Planning Subcommittee, provide an optimistic view of the CTS' s ability to maintain reliable transfers of 2200 MW under a variety of resource futures.

### **Significant Findings:**

1. Remedial Action Schemes (RAS) will be necessary for any new generation acquiring firm transmission service across the CTS. All of the studies reviewed by this Subcommittee assumed a sufficient RAS. This new RAS will have to coordinate with the Accelerated Trend Relay (ATR) RAS at Colstrip as long as any of the Colstrip units are in operation. The new RAS will be developed as a part of the transmission/interconnection study request for a specific generator and is not anticipated to be a major cost or technical barrier. For a more thorough consideration of the potential RAS design options, see the link to the whitepaper by Chuck Stigers in Appendix H.
  - a. BPA relies heavily on RAS to maintain the transfer capability across its network. Since BPA's RAS depends upon high speed communication between line sensing facilities, generator projects, and BPA's RAS controllers, BPA has extensive experience with installing communication facilities for a number of Large Generator Interconnection Agreement (LGIA) projects and for transmission line projects in recent years.

The cost of installing RAS will almost certainly be less than the addition of more linear transmission facilities since the RAS is, by design, intended to avoid or save the cost of those facilities. Costs for installing RAS on BPA's system do vary significantly depending on location of the interconnection facilities to existing communication facilities. Costs can range from the tens of thousands of dollars for projects located near existing communication facilities up to hundreds of thousands or potentially a few million dollars for more remote locations.
2. Under steady state conditions, studies performed to date did not identify thermal limit violations for any of the scenarios and did not identify new transmission lines are required (as long as the 500 kV system is intact).
3. The studies that conducted dynamic stability analysis also found that the system performed reliably under stress, with no voltage excursions. In some cases frequency concerns lessen when coal is replaced with wind. Wind generation plants do not inherently add a significant amount of inertia to a transmission system; they add some, but certainly not as much as a coal-fired plant. However, there is an opportunity for wind generation plants to add more inertia than they would otherwise if they are equipped with wind inertia controls (for example, WindINERTIA by GE) which allows the wind generation plant to act as if it has inertia enabling it to contribute to frequency control. Certainly, wind generation plants located in the Billings area will likely have an easier time contributing to frequency control than plants located in the Colstrip area as they would not have to interact with radial 500 kV system between Colstrip and Broadview (Billings).

## Appendix B

4. Under some scenarios, adequate voltage support in the Billings, MT area may be a concern; the location of replacement generation may help address this concern.
  - a. Billings-specific locations for new generation would likely be more beneficial to supporting voltage than locations in the Colstrip area. Voltage is controlled by reactive power which doesn't "flow" as readily as real power. NWE requires a 0.9 leading/lagging power factor for any new generation projects interconnecting to its transmission system. This power factor allows for more voltage support than the historical requirement of 0.95 leading/lagging. This extra range of voltage support for new generators will be beneficial to the transmission system.
  - b. Voltage control devices do not always have to be in the form of new generation. For example, due to the loss of the Corette plant, NWE installed 80 MVAR (millivolt ampere reactive) of new capacitor banks to account for the loss of voltage support previously supplied by the Corette plant.

Additional voltage control measures might include various storage projects, including pumped storage, the addition of switched capacitors (to relieve low voltage), or switched reactors (to relieve high voltages). More elaborate measures could involve the use of electronically controlled devices such as Static VA r (volt ampere reactive) Compensators (which provide continuous operation over a range of voltage conditions) or possibly the use of synchronous condensers. Synchronous condensers would behave similarly to turbine generators, but do not have the ability to also provide real energy (or MWs).

5. The 500 kV system is an essential component of reliable load service within Montana as well as for supporting exports to the Pacific Northwest. In the face of retiring Colstrip units, changes to the transmission system and/or operations are inevitable. Adding new generation in the vicinity may provide additional benefit to the transmission system to help mitigate the loss of the Colstrip generating resources.
  - a. Without the 500 kV CTS system, a 230 kV line would have to be built to reinforce the South of Great Falls cut plane.
  - b. If all coal in Montana is retired and no replacement generation is put in place, one of the parallel 500 kV lines comprising the CTS may have to be de-energized.

### **Additional Study Work Required to Interconnect New Generation:**

Transmission planning studies and other studies will have to confirm the results of the generic studies reviewed by the Planning Subcommittee once specific generators are identified. The Planning Subcommittee acknowledges that the following questions would be addressed in each individual generator's formal interconnection process:

1. Local voltage control issues: Depending on the location of new generation local voltage control, issues may need to be addressed, especially in the Billings, MT area. Most wind machines today can produce VAr output even when they are stopped; using such machines will help mitigate

voltage concerns. If necessary, Voltage Source Converters could be placed near Billings, MT and are not cost-prohibitive.

2. Sub Synchronous Resonance (SSR): Frequency scans should be conducted for each generator interconnection to test for SSR concerns. Recent interconnection study work for the Gordon Butte Pump Storage project did not identify any SSR concerns under the current transmission configuration.<sup>11</sup>
3. RAS Design: As discussed in detail above, RAS designs will have to be specified and implemented as part of each new generators interconnection process.

### **Blackstart:**

Blackstart studies are required to confirm that a system can recover from a complete system blackout/outage. Such studies are required every five years, or within 90 days of a major system change. The last blackstart study conducted by NorthWestern was in 2017 and did not include the now planned closure of Colstrip Units 1 and 2. NWE's current plan is to follow the regular cycle and initiate the next blackstart study in 2021 (for finalization in 2022), which aligns nicely with a 2022 retirement of Colstrip Units 1 and 2.

Historically, the NWE blackstart plan has been to use hydropower facilities to start the system, and then to "grow" the island of in-service components to the point where one of the Colstrip units could be started without causing extreme voltage or frequency excursions on the transmission system. NWE is well-prepared to meet the requirements of NERC EOP-005 under a variety of resource and topology scenarios by utilizing the hydropower resources, Dave Gates generating station, Colstrip Units 3 and 4, and imports from neighboring systems.

Given the various options for implementing a viable blackstart plan, the Planning Subcommittee does not anticipate this requirement to be overly burdensome without Colstrip Units 1 and 2. It also may be premature to perform such an analysis today as the analysis itself depends solely on the topology of the transmission system at the time of the study; conjecture could lead to an inaccurate blackstart plan. NWE has acknowledged the need to start thinking about how the blackstart plan would look if no Colstrip units were available, however, until the actual topology of the system is known, NWE will not be initiating a post-Colstrip blackstart analysis.

The Planning Subcommittee supports NWE's plan to wait until 2021 for the next regularly scheduled blackstart study consistent with reliability requirements. This recommendation is based on our understanding that a blackstart study must be completed with 90 days of a major system change.

With respect to the MRDAP's focus on renewable energy, NWE does not plan to use wind generation resources as part of its blackstart plan as there is no guarantee that the wind will be blowing in the event of a blackout.

### **Impacts of an Unexpected, Sustained Outage of Colstrip Units 3 and 4:**

Additional analysis confirming the ability of the CTS to maintain its current path rating if none of the Colstrip Units were available for service on an extended basis will be required at some point. This

---

<sup>11</sup> <http://www.oatioasis.com/nwmt/nwmtdocs/Project310-SystemImpactStudy.pdf>

## Appendix B

analysis would be similar to the work NWE is currently conducting for Units 1 and 2 and would take approximately six months to develop the assumptions and an additional six months to conduct the study work. The retirement of the ATR and any impacts on RAS for new generation would also need to be considered.

Existing studies have looked at: 1) no coal in Montana (with no replacement energy and different mixes of wind and gas replacement), and 2) the retirement of CS Units 1, 2, and 3 (with equal amounts of wind and other replacement energy added). This work tells us that without any coal and no new resources added, some relatively minor system changes may be needed (de-energized parallel 500 kV lines or reactive additions) but it is feasible that the system can support a MW-for-MW replacement resource.

The study scope for examining the impacts of units 1-4 retiring would need to consider the following:

1. Queued generation: there are multiple projects on either the 500 kV CTS or on the 230 kV buses that connect to the CTS; assume that all projects will achieve interconnection.
2. Assume firm transmission service for any projects interconnecting to the CTS, either 500 kV or 230 kV; in some instances, this may mean having to identify upgrades on the 500 kV system to accommodate all the requests. It is suggested that parties draw upon upgrades identified in the M2W project.
3. Assume that the 500 kV system is no longer directly tied to generation output from the current Colstrip units and will remain as an intact system.
4. Assume sufficient RAS are in place for each of the generation projects that have achieved interconnection and firm transmission service; and that each RAS doesn't negatively impact another RAS on the system.
5. Assume appropriate load growth for the projected year of study.
6. Assumption of all other coal on the system needs to be considered.
7. Assume that any regionally significant projects currently in proposal will be considered – perhaps only consider those projects that are at least in Phase 2 of the WECC path rating process.
8. Assume that any new wind generation plants will have some form of inertial controls.
9. As there will no longer be any Colstrip coal-fired units, assume no ATR

Additional decisions about the study parameters will also have to be made. For example, whether the study analyze the retirement of all coal in Montana or just the Colstrip units, and whether the study considers new transmission lines necessary to serve all resources in NorthWestern's transmission and interconnection queues, or just enough to utilize the freed up capacity from coal retirements.

One scenario that may be of nearer term concern and that has not been studied to date, is what happens if Units 1 and 2 are replaced with 610 MW of wind, and later Units 3 and 4 are also retired but not replaced with any new generation.

Several Planning Subcommittee participants have emphasized that there is urgency and interest to the State of Montana in understanding the implications for the Colstrip Transmission System if all Colstrip Units were to retire. The Planning Subcommittee has laid out a scope of work that will need to be completed when there is enough new information that would substantially change the inputs, and thus the findings, of the previous studies.

## Appendix B

The Planning Subcommittee supports the completion of the scope of work outlined here at the appropriate time when more information about the future topology of the system is available, prior to any planned retirement of Units 3 and 4 and ideally in conjunction with firm information about any replacement resources. Regional planning organizations such as ColumbiaGrid and Northern Tier Transmission Group should be engaged in the retirement scenario planning. The scope of work can serve as a guideline for more detailed study work when the time is right. In the event of an extended outage of Units 3 and 4, the Planning Subcommittee recommends that the WECC expedited path rating process and the study scope described here be implemented as soon thereafter as reasonably possible.

### WECC Path Rating Questions:

The WECC Path Rating process will be undertaken on an advantageous schedule – with retirement of Colstrip Units 1 and 2 and identification of replacement resources examined together.

The current WECC Path 8 (Montana to the Northwest) Accepted Rating is 2,200 MW. There has been concern whether the path rating can be maintained as the coal fired generation at Colstrip retires. Two different outcomes could force the path to be subject to re-rating under WECC's Three Phase Rating Methodology. First, when Colstrip Units 1 and 2 retire, it may appear that the owners of the path (NWE, AVA, and BPA) would be required to pursue a de-rate of the path. Second, as replacement resources become clear for the retired resources at Colstrip, the transmission owners would then be required to pursue an uprate back toward the original rating.

While a de-rate study could be possible with the retirement of Colstrip Units 1 and 2, the owners have had informal discussion with WECC indicating that there is not a plan to immediately pursue a de-rate of Path 8 prior to the retirement of Colstrip Units 1 and 2, but rather an appropriate path rating (up-rate or de-rate) would be pursued at such time as the owners have clarity around the retirement of Colstrip Units 1 and 2 and the replacement resources. Feedback from WECC was generally supportive of waiting for clarity rather than proceeding to a de-rate study only to be followed by an up-rate (or re-rate) study. If a de-rate study is necessary, the transmission owners could seek an expedited review of the path rating.

Such a treatment is consistent with the treatment of other WECC paths with an Accepted Rating.

The Planning Subcommittee supports the selection of an appropriate time to pursue WECC rating for Path 8 and do so in a timely fashion for the retirement of Colstrip Units 1 and 2. Immediate action is not warranted at this time. When the transmission owners pursue an updated WECC rating for Path 8, they should include any system reinforcements not previously considered (such as the completed improvements Avista discussed in the Colstrip Transmission Upgrade section).

### Remedial Action Scheme Changes:

The transmission capacity of Path 8 (Montana to the Northwest) and Path 6 (West of Hatwai) are supported by existing Remedial Action Schemes (RAS). For Path 8, the RAS is supported by a protection scheme local to the Colstrip plant known as the Acceleration Trend Relay (ATR). The ATR measures system voltages and angles as well as the shaft speed of the generation at Colstrip. The ATR

## Appendix B

can trip as many units as needed in response to deviations in the Colstrip generation shaft speed (and acceleration) with respect to the system angles in order to preserve the stability of the transmission system.

The studies done by Northern Tier Transmission Group (NTTG) and NWE, as well as the white paper by Chuck Stigers all acknowledge that RAS will continue to be necessary as coal fired generation at Colstrip retires in order to support the reliable operation of the path. Those studies (and white paper) anticipate that the ATR RAS will continue to support reliable operation of the path as Colstrip Units 1 and 2 retire. Replacement generation will, however, need to participate in RAS; the RAS for the replacement resources will need to coordinate with the existing ATR RAS.

NWE is in the early stages of planning for the next generation of ATR and intends that the ATR will likely need to be designed assuming a different generation configuration at Colstrip and also be able to incorporate non-Colstrip generation into the RAS. NWE, supported by AVA and BPA, will need to work together to make appropriate design decisions for the RAS modifications to continue to support reliable operation of the transmission system.

While the Transmission Owners have not made any design decisions on how to coordinate with the Colstrip ATR or what a RAS implementation might be if all coal fired generation at Colstrip is retired, the Transmission Owners anticipate that they will be able to identify appropriate schemes that will support the reliable operation of the system in a timely fashion.

It is also important to note that Transmission Owners have a common interest to have a viable scheme(s) to maintain transfers across Path 8. The Transmission Owners will work together and with the developers of replacement resources to ensure the timely incorporation of the RAS system needed to provide service to accommodate the needs of the transmission system.

Given the expectations that new RAS can be developed in a timely fashion, the Planning Subcommittee supports waiting until the formal generator interconnection process to design the new RAS.

### Recommendations:

1. Studies must be done in a formal interconnection process when specific generators are identified to include:
  - a. Local voltage control
  - b. Sub-synchronous resonance
  - c. RAS design
2. A Scope of Work should be developed to guide the studies needed should a future retirement or an unexpected, sustained outage of Colstrip Units 3 and 4 occur.
3. NorthWestern should undertake timely blackstart, sub-synchronous resonance mitigation, RAS, and WECC Path Rating requirements when specific replacement generation for Colstrip unit retirement is identified and the technical attributes are known.



## Appendix B

4. For service on the existing BPA Network, BPA should consider:
  - a. Administrative changes that should result in additional ATC availability
  - b. A Conditional Firm product on its external interconnections (especially as a bridge product)
  
5. For potential expansion of the BPA Network, BPA should consider flexible, scalable options to meet service requests across BPA Network Flowgates including: non-wires solutions, planning re-dispatch, storage, and demand side management.

## Operations Subcommittee details

The Operations Subcommittee was charged with examining the operational aspects of three broad categories: investments and/or controls needed to preserve reliability anticipating the retirement of Colstrip Units 1 and 2, the Dynamic Transfer Capacity (DTC) limits that may impact the movement of power from renewable replacement generation in Montana following the retirement of this generation, and the ancillary products needed to integrate Montana wind.

Reliable operation includes compliance with mandatory reliability standards set by the North American Electric Reliability Corporation (NERC) and the Western Electricity Coordinating Council (WECC).

### **Generation Loss Impacts:**

When Colstrip Units 1 and 2 retire, there is an impact from the loss of the inertia, frequency response, and voltage support provided by this generation.

Variable Energy Resources that replace output no longer provided by the Colstrip Units will need to participate in the Remedial Action Schemes (RAS) to quickly drop or run back generation following a contingency. This participation is needed to preserve the 2200 MW East to West Path 8 rating<sup>12</sup> and the 2000 MW Montana to BPA rating (capacity may be raised to 2200 MW with adequate RAS installed on new generation). They will also need to provide local voltage support (amount determined by their location), and frequency response if required by detailed studies once the replacement generation location and technical characteristics are known. It should be noted that the loss of the Colstrip Units 1 and 2 frequency response has not been shown to be a reliability risk in the WECC Region.

Another option may be to consider retaining Colstrip units to serve as synchronous condensers. Generators operating in condensing mode are spinning masses that produce voltage support and some inertia for damping during contingencies. They produce reactive power, but not real power. They ‘motor’ on the system and as such, do not consume fuel. Nothing in the owners’ decommissioning requirements would preclude such an option, however, the choice to exercise it would depend on detailed engineering studies when replacement generation location and characteristics are identified and all owners agree that it represents the best value alternative for provision of voltage support and inertia needs. There may be other commercial or contractual issues that could make this option difficult to realize. Other options are also available, including pumped storage and reactive devices.

### **Dynamic Transfer Capability:**

Dynamic Transfer Capacity (DTC) is the quantity of power flow movement over a transmission path that can be accommodated within-hour without violating voltage limits. See Figure 2.

---

<sup>12</sup> From the WECC Path Rating Catalog – See Appendix E

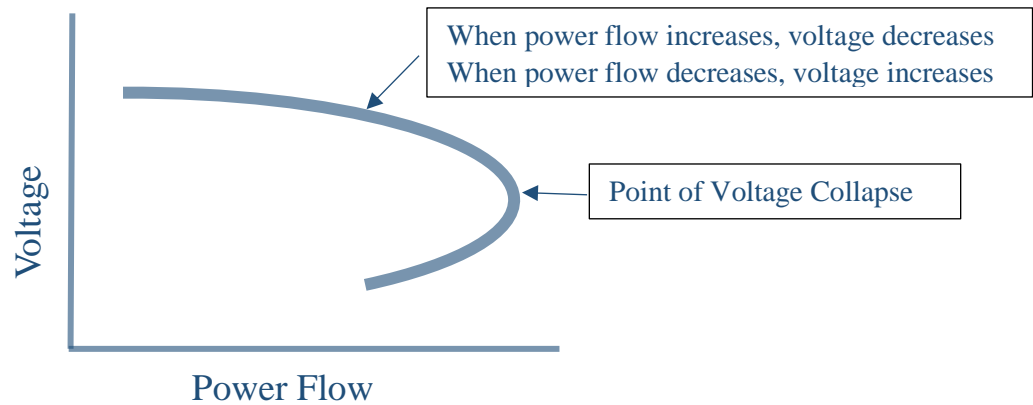

Figure 2 – P-V Curve

The percentage change in voltage allowed can vary by path. The DTC limit on a transmission path is determined such that the change in voltage does not require operator intervention to mitigate (inserting or removing a shunt reactive device). Studies analyze the changes in voltage for corresponding changes in power flow to produce a nomogram. The most limiting value from the nomogram is set as the DTC limit. While exceedance of a DTC limit does not result in immediate system degradation, it can put the system in an unreliable or suboptimal state, and mitigation is needed to restore the system to one that is ready to withstand the next potential contingency.

NorthWestern does not have a DTC limit on its system. BPA studied the Garrison interchange point and confirmed a 2011 study done by the Wind Integration Study Team (WIST) which included scenarios for both high and low generation at Montana's hydro plants. The DTC limit at the Garrison interchange point is +/- 170 MW for a dynamic range of 340 MW.

There are currently no DTC limitations between BPA and other northwest parties. The DTC limit on the Montana Intertie at the Garrison interchange point would keep these transfers low enough not to adversely impact transmission paths. If the Garrison interchange point DTC is significantly increased in the future, interchange points further west may then be limiting.

The capacity of wind that can be integrated is much greater than the DTC across the Montana Intertie. This amount is dependent on a number of factors, including the diversity of the wind and the location of the balancing resources. BPA has performed preliminary studies that show that more than 1000 MW of wind could be supported by the current amount of DTC, even without balancing or shaping of that wind on the eastern side of the intertie.

DTC is consumed when resources' output varies within the hour. BPA has determined that movement in one direction only does NOT consume DTC on the Montana Intertie. Once BPA can integrate this assumption into its DTC practices, this will further increase the amount of wind that can be supported by the DTC on the Montana Intertie.

The DTC limit can be approximately doubled by automating voltage control actions on the transmission reactive devices. This option would not be cost prohibitive as only local controls would need to be added to shunt devices already deployed. In the preliminary studies performed by BPA, this doubling of DTC would at least double the amount of wind that could be supported by that amount of DTC.

### **Ancillary Products:**

In past years, BPA conducted a study of a representative wind plant located in Montana integrated with wind resources in the Columbia River Gorge. The study found that the incremental increase in the balancing reserve requirement was 25% that of a same size plant in the Gorge. Additional studies will need to be conducted to determine if these results still hold for current system topology and recognizing that as more variable energy resources are added in Montana, the percentage will change (increase). As of this writing, BPA has executed non-disclosure agreements with Montana wind plants to secure actual wind data to confirm the diversity benefits and balancing reserve requirements to confirm and update these results within the next two months.

NorthWestern is currently finalizing studies that identify regulation and load following requirements for current wind resources as well as for additional wind and utility scale solar resources. These results should be available within the next quarter.

In addition, if flexible resources (e.g., pumped storage) were utilized on the eastern side of the Montana Intertie, their use for balancing would lessen the impact on the DTC.

### **Significant findings:**

1. NorthWestern does not have a DTC limit on its system.
2. +/- 170 MW (340 MW dynamic range) of DTC is available at the Garrison interchange.
3. The capacity of wind that can be integrated is much greater than the DTC across the Montana Intertie. This amount is dependent on a number of factors, including the diversity of the wind and the location of the balancing resources. Given preliminary studies, more than 1000 MW of wind can be supported within the current DTC limit.
4. DTC is consumed when resources are moving around within the hour. Movement in one direction only is deemed NOT to consume DTC on the Montana Intertie. Once BPA can integrate this assumption into its DTC practices, this will further increase the amount of wind that can be supported by the DTC on the Montana Intertie.
5. DTC can be increased (approximately doubled) by automating voltage control actions on transmission reactive devices. This option would not be cost prohibitive.

## Appendix C

6. There are no DTC limitations between BPA and other NW parties for movement of Montana wind. The DTC on the Montana Intertie is the only applicable DTC limit at present.
7. If DTC on the Montana Intertie is significantly increased in the future, interchange points further west may then be limiting.
8. If a wind plant located in Montana is integrated with wind resources in the Columbia River Gorge, the incremental increase in the balancing reserve requirement is 25% that of a same size plant in the Gorge. (Other Balancing Authorities would have different outcomes depending on the characteristics of their other renewable resources).
9. There are potential flexible capacity resources on the eastern side of the Montana Intertie (e.g. pumped storage). Because these resources would be on the same side of the intertie as the potential wind, their use for balancing would lessen the DTC impact.
10. Variable energy resources will need to participate in Remedial Action Schemes (RAS), provide local voltage support, and potentially frequency response. Retaining Colstrip units to serve as synchronous condensers (to provide voltage support and inertia) may be an option.

### **Recommendations:**

1. BPA should determine that resource output in only one direction within an operating hour does not consume DTC.
2. BPA should implement a business practice to operationalize the decision that resource output in only one direction within an operating hour does not consume DTC.
3. Studies should be performed using actual Montana wind data to confirm the diversity characteristics and balancing reserve requirements of Montana wind resources.
4. NorthWestern's studies should be finalized that identify regulation and load following requirements for both existing and additional wind and solar resources.
5. The viability of utilizing Colstrip units in condensing mode to provide voltage support, inertia, and frequency response should be studied. Generators operating in condensing mode are spinning masses that produce voltage support and some inertia for damping during contingencies. They produce reactive power, but not real power. They 'motor' on the system and as such, do not consume fuel. Nothing in the owners' decommissioning requirements would preclude such an option, however, the choice to exercise it would depend on detailed engineering studies when replacement generation location and characteristics are identified and all owners agree that it represents the best value alternative

## Appendix C

for provision of voltage support and inertia needs. There may be other commercial or contractual issues that could make this option difficult to realize.

INTERFACE CAPACITY SETTLEMENT AGREEMENT BETWEEN BONNEVILLE AND NORTHWESTERN ENERGY

SUMMARY

Bonneville and Northwestern have disagreed about the amount of east-to-west interface capacity that Northwestern has directly to Bonneville's network transmission system in western Montana. Northwestern maintains that it has 184 MW of network-to-network interface capacity in excess of the 308 MW of interface capacity that Bonneville and Northwestern agree on. Bonneville maintains that it has an exclusive right to sell the disputed 184 MW on its Eastern Intertie segment under the Montana Intertie Agreement. Both Parties agree that a sale of the disputed 184 MW by one Party would preclude the other Party from selling the capacity.

Bonneville and Northwestern have reached an agreement to settle the issue under which both parties will post the same 184 MW. If a party submits a TSR to Northwestern in excess of its 308 MW of posted LTF ATC, Northwestern will purchase the incremental capacity needed from Bonneville for the same term as the TSR requested by the Customer. This will give the Customer a continuous path from Northwestern to BPA, without the Montana Intertie rate pancake. In order to facilitate the transaction with the Customer, Northwestern will make such incremental capacity purchase, up to 184 MW through BPA's OASIS subject to the terms of the OATT and at BPA's posted rates for the E. Intertie. The Colstrip Parties to the Montana Intertie Agreement will receive any appropriate credit under the Montana Intertie Agreement for any purchase of capacity made by Northwestern. Specific, detailed scheduling and implementation procedures between Bonneville and Northwestern will be developed over the next several months.

This arrangement has the benefit of offering optionality to developers in MT on which transmission path to use to access to the Bonneville Network and an increased likelihood of BPA selling the remaining 184 MW on the E Intertie and thus providing all CTS parties a credit.

Northwestern intends to file this agreement at FERC in July and it will be effective upon approval by FERC. Either party can terminate the agreement with 30 days notice, however there are limitations to this if service on Northwestern that requires a portion of this 184 MW has been requested or BPA has granted such service.

### MT to PNW - Existing System and Capacity

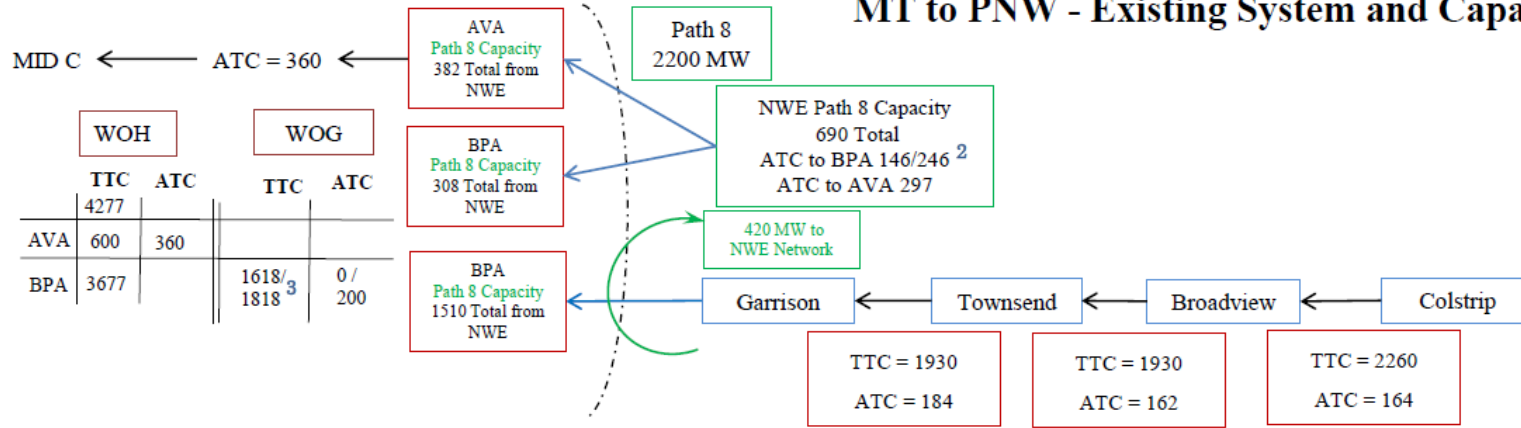

BPA Network	Rights Holder		BPA Eastern Int.	Colstrip Tx System	
West of Garrison TSRs	Rights Holder		T'send-Garrison TTC / ATC	B'view-T'send TTC / ATC	Colstrip-B'view TTC / ATC
757 <sup>5</sup>	PSE	PSE	680 / 0	759 / 96	746 / 83
270	PGE	PGE	280 / 0	312 / 5	308 / 0
205	AVA	AVA	210 / 0	234 / 12	230 / 8
156	PAC	PAC	140 / 0	156 / 0	154 / 0
0	NWE	NWE	420 / 0	469 / 49	823 / 73
230 <sup>4</sup>	Other	BPA	200 / 184	0 / 0	0 / 0
1618 <sup>3</sup>	Total		1930 / 184 <sup>1</sup>	1930 / 162	2260 / 164

1. BPA sales of 16 MW to PAC on Eastern Intertie
2. 146 MW ATC as of Feb 2018; 246 MW ATC in Jan 2019
3. 1818 MW w/RAS; 1618 MW w/o RAS
4. BPA WOG "Others": SNOPUD (50 MW, 5/48) , PPLM (100 MW, 7/20), PWRX (80 MW, 12/22)
5. Termination dates: 663 MW Aug 2019, 94 MW Oct 2021

For informational purposes only  
 Compiled from publicly available sources



MEMORANDUM

From: Tom Schneider and Chuck Magraw<sup>13</sup>

To: MRDAP Steering Committee  
MRDAP Commercial/Policy Subcommittee  
MRDAP Planning Subcommittee

Subject: The Colstrip Transmission System: Its Value to Montana and Planning for Its Future

Date: May 25, 2018

---

**Background.** The Montana Renewable Development Action Plan process was convened in order to address issues related to the development and transmission of Montana based renewable energy to Pacific Northwest markets. Part of the consideration of these issues necessarily involves whether and how the Colstrip Transmission System (CTS) is utilized in future decades after changes in Colstrip generation. In considering these issues, at least a few points are salient:

- Large thermal coal-fired generation units (including Colstrip Generation Station Units 1 and 2) are being retired across the region.
- It is not unreasonable to assume that at least some of the future generation that will replace these coal-fired plants will be renewable generation (wind and solar).
- The impending retirement of Colstrip Units 1 and 2 (by no later than 2022); the expiration of the Montana Intertie Agreement (MIA) in 2027 (with prior notice provisions); and the eventual retirement of Colstrip Units 3 and 4 will change how the Colstrip Transmission System (CTS) will be utilized and/or operated in the future.
- As capacity opens up on the CTS, Montana has an opportunity to develop its wind resources for sale to Pacific Northwest customers.
- Montana resources can satisfy Washington RPS standards through dynamic transfers between Montana and the BPA system.
- Existing transmission infrastructure, like the CTS, is too valuable to abandon. It should be fully utilized to keep Montana's energy export industry alive.
- It would be helpful for regional planning and policy decision makers (specifically the CTS owners, the Bonneville Power Administration, and the region's state utility commissions) to establish a logical process that will facilitate the evolution of the CTS and regional grid modernization.

**In short, it is our contention that** the CTS should continue to provide reliable and cost-effective access to Montana resources for the benefit of the Pacific Northwest region for which it was constructed. While the

---

<sup>13</sup> This memorandum expresses the views of its authors and does not necessarily reflect the consensus of any MRDAP committee or subcommittee.

## Appendix F

available resources may transition over time from coal to renewables, Montana resources can continue to benefit the Pacific Northwest.

Below we identify three steps that we think advisable to ensure the continued viability of the CTS and that it remains an essential component of the Pacific Northwest's regional transmission system.

**1. The Montana Intertie and Colstrip Transmission System Agreements need to be reviewed and updated, as appropriate.** The five CTS owners and BPA should enter into (or continue) discussions and negotiations to resolve, at the earliest practicable time, issues related to the future use of the MIA/CTSA. We further recommend that any modifications, if necessary, to the MIA/CTSA be based upon open access principles that will facilitate repurposing and full and efficient access to, and utilization of, the Colstrip 500 kV system from Colstrip to Garrison.

**2. The export opportunities from Montana wind generation should be considered by the region's utilities.** In their integrated resource plans Pacific Northwest utilities should consider the inclusion of Montana sited wind generation, which not only has a high capacity factor but is a good fit with regional loads.

**3. Long-term transmission planning studies need to be undertaken.** The magnitude of regional coal retirements, including those at Colstrip, require that technical long-term planning studies be undertaken in a timely fashion. This is necessary in order to provide substantive guidance for regional stakeholders and inform transmission and resource decision-making in Montana and the Pacific Northwest.

These transmission planning studies should include:

- Robust assumptions and rigorous ongoing analyses, including a range of likely resource areas and technical interconnection characteristics through collaboration of the appropriate regional entities such as NTTG and Columbia Grid to ensure strong stakeholder participation.
- A methodological approach and analysis to address the full range of technical reliability issues ultimately required under scenarios that do not include Colstrip Units 1-4 (and other coal resources) to satisfy reliability requirements such as path rating, RAS, inertia, frequency, voltage, VAR, stability, etc. as routinely recognized and completed by utilities in Montana and the Pacific Northwest.

## Appendix G

From: Policy/Commercial Subcommittee

Re: Statement on Market Principles

Date: June 20, 2018

Electric utilities throughout much of the Western United States administer separate tariffs and balancing authorities, outside of a regional transmission organization (RTO) and/or regional electricity market. The notable exception is the California ISO, who has operated an RTO since 1998, and is the only RTO operating in the western United States. While there have been several attempts to form a regional transmission organization/electric market outside the CAISO across the West, those efforts have failed for various reasons, including (but not limited to) governance and costs. Recently, however, there appears to be momentum behind establishing an organized electric markets in parts of the west. There are efforts to expand the services offered by CAISO,<sup>14</sup> through the Western Energy Imbalance Market, and there are discussions among Southwest utilities about joining SPP.

Many of the issues that this subcommittee has been asked to address concern cost allocation, tariffs, transmission planning, and coordinating these processes across multiple transmission systems owned by different entities. If an RTO/market is designed correctly, it would address each of these issues, to varying degrees. Accordingly, this policy subcommittee put forth the following principles to aid in the decision-making framework on this issue.

### Principles

1. The present real-time EIM, and even the current conception of the geographically expanded day-ahead market, would not by themselves streamline the issues new generators face when trying to coordinate long-term transmission service across multiple transmission providers. It would likely assist with integration costs, but it would not address the need to coordinate multiple transmission requests.
2. As it relates to the work of this subcommittee, a full RTO's benefits would include: 1) eliminating the need to coordinate transmission service requests across multiple tariffs, 2) possibly reducing or eliminating pancaked transmission rates, and 3) likely reducing integration costs. A full RTO does not currently exist outside CAISO, however.
3. While many of the general benefits of a west-wide RTO are well understood, the costs can be significant and at present have not been meaningfully studied.
4. The costs, risks, and benefits of any market, whether the EIM or a full RTO, can also be idiosyncratic, depending on market design, connectivity, scale and proximity.

---

<sup>14</sup> The EIM, which CAISO introduced in 2014, provides a real-time balancing market for intra-hour energy to participating entities outside of CAISO's traditional footprint. To date, eight entities have joined this market and four more are expected to join by 2020, and the ISO is currently exploring how it might expand its EIM market to offer a day-ahead market outside of California.

## Appendix G

5. Governance issues are critical because they affect key decision points such as the allocation of costs and benefits. Efforts to form a full RTO should therefore have a strong focus on governance issues, in addition to issues of the design of procedures and markets.

## **Review of Available Studies Assessing Transmission System Impact from Shutdown or Closure of Coal Fired Generation at Colstrip**

### **Introduction**

During the review and discussion of information for the MRDAP, one of the key issues raised by developers of wind resources in Montana involved understanding how much transmission capacity might be available or what expansion might be needed in order for them to be able to put together a suitable business plan for their projects. In other parts of the interconnected network, developers seek transmission access through open access processes such as Large Generation Interconnection Agreements (LGIA) and requesting transmission service on Open Access Same-time Information Systems (OASIS). For the most part, the existing fleet of generation resources is set or known – the changes in resource portfolios local to where developers are seeking interconnection generally are due to the *addition* of new resources.

Montana poses a unique situation for developers. Montana is currently a generation surplus portion of the country – much of the electrical energy produced in Montana is exported and used in other parts of the Western Interconnection (primarily the Pacific Northwest). Colstrip, the largest generation project in Montana (not coincidentally a major exporter of power from Montana) expects to retire Units 1 and 2 from power production in 2022. While the transmission system that supports Colstrip is expected to remain in service, many questions regarding the ability of the transmission system to continue to support transfers of energy from new resources both within and outside of Montana have arisen. The Planning Committee for the MRDAP began to consider some of the technical issues around the closure of the Colstrip generation plant.

The questions pondered by the Planning Committee surrounding the shutdown of coal fired generation at Colstrip have been in the making for several years given the likelihood of unit retirement along with strong interest in developing wind resources in Montana. Prior to formation of the MRDAP effort, the Northern Tier Transmission Group (NTTG) and NorthWestern Energy have already performed several studies (as long ago as 2014) that investigated the impact to the transmission system from the shutdown of coal fired generation at Colstrip. A listing of those studies and a high level view of the study effort is included in the table below.

Appendix H

Study	Generation Shutdown	Replacement Generation	Transient Study?
Study #1: Conducted by Northern Tier Transmission Group NTTG Study Report for the 2014 - 2015 Public Policy Consideration Scenario Committee Approval: May 13 <sup>th</sup> , 2015	Colstrip 1 & 2 ~600 MW	Wind at Broadview	No
Study #2: Conducted by Northern Tier Transmission Group NTTG Study Report for the 2016-2017 Public Policy Consideration Scenario Committee Approval: May 10 <sup>th</sup> , 2017	Colstrip 1 & 2 Possible Unit 3 ~1,500 MW	Wind (~1,500 MW at Broadview), Gas (250 MW at Alkali Creek), & Combined Wind/Gas	Yes
Study #3: Conducted by NorthWestern Energy EPA 111-D Consideration Retirement of CS units 1&2 April, 2015 Regional Electric Transmission Planning	Colstrip 1 & 2 ~600 MW	Wind (at Broadview), Gas, & Combined Wind/Gas	Yes
Study #4: Conducted by NorthWestern Energy EPA 111-D Clean Power Plan Consideration Study: Retirement of All Coal-Fired Generation in Montana November 2015	Colstrip 1 thru 4 Plus all coal generation in NWE BA (~2,500 MW)	Wind (~2,500 MW), Gas (250 MW), & Combined Wind/Gas	Yes

Studies conducted to evaluate the transmission system impact from shutdown of coal fired generation at Colstrip while being replaced by other generation resources in Montana.

Some participants in the MRDAP suggested that further study would be necessary in order to provide certainty about the capability of the transmission system. The Transmission Owners (TO) of the transmission system – led by NorthWestern Energy, and supported by BPA and Avista – suggested that the MRDAP effort would not be the suitable venue for such studies. The TOs suggested two limitations to performing studies under the MRDAP:

- Without clarity about what the replacement resources for the Colstrip generation would be, resultant studies would not provide the certainty sought from the study. They could only provide limited information beyond that already covered in the studies already completed.
- The limited time scope for the MRDAP (roughly six months) would not allow for completion of new study work.

Given the short timeframe for this project and the lack of specifics about the location and characteristics of replacement generation, the Planning Committee made maximum use of the

## Appendix H

existing studies such as NorthWestern's Colstrip Shutdown Reports and the NTTG Studies, and considered a white paper by Chuck Stigers.

### **Findings from the Completed Studies**

All of the studies were performed at a high level with a limited set of scenarios considered. Since the exact projects – including type, size, and location – that might replace the generation at Colstrip would not be known, the nature of assumptions and scenarios to consider relied on typical interconnection data with assumed, rather than actual design information. The studies also made similar assumptions about some of the transmission system such as location and capability of critical equipment including necessary Remedial Action Schemes (RAS) that would remove generation from the transmission system in response to critical contingencies.

Even with the higher level of detail assumed in the studies, all of the studies did find confidence that replacement resources can integrate into the existing transmission system on a MW-for-MW basis with the retiring generation at Colstrip. The studies provided results that suggest the transmission system will be able to continue to operate reliably while maintaining the transfer capability to the existing system. The studies also consistently noted that RAS will remain an important part of supporting the existing transfer levels of the existing system. New resources will need to be incorporated into the RAS that must coordinate with the existing Acceleration Trend Relay (ATR) that provides needed generation tripping in response to critical contingencies on the existing system. The ATR is expected to provide the foundation for RAS in Montana as long as coal fired generation at Colstrip continues to operate. If all of the generation at Colstrip were to close down, the ATR RAS would need to undergo a new design. Another key finding from the studies was the demonstration that the 500 kV system that integrates the transmission system in Montana with the Pacific Northwest is essential for service to customers within Montana with or without the need to export power from Montana (to the Northwest).

#### **Study #1:**

##### **Conducted by Northern Tier Transmission Group**

##### **NTTG Study Report for the 2014 - 2015 Public Policy Consideration Scenario**

##### **Committee Approval: May 13, 2015**

The first study reviewed was a Public Policy Consideration completed by the Northern Tier Transmission Group that investigated the impact of shutdown of Colstrip Units 1 and 2 to the transmission system. The study considered replacement of the Colstrip generation with ~600 MW of wind generation integrating near the Broadview 500 kV substation. The study did not include an assessment of transient performance.

With the assumption that RAS could be incorporated to trip the replacement generation in response to critical contingencies, the study supported the conclusion that wind generation interconnected to the 500 kV system near Broadview could possibly replace the retired generation from Colstrip Units 1 and 2.

**Study #2:**

**Conducted by Northern Tier Transmission Group**

**NTTG Study Report for the 2016-2017 Public Policy Consideration Scenario**

**Committee Approval: May 10, 2017**

Study #2 also considered the shutdown of Colstrip Units 1 and 2 (~600 MW) along with the possible closure of Colstrip Unit 3 (~900 MW). The study replaced the retired generation with wind (~1,500 MW) or wind (~1,250 MW) and gas (250 MW). Unlike Study #1, the study did not include an assessment of the transient performance of the system as well as a limited production cost study.

The study found that with ATR tripping for the existing system or coordinated equivalent RAS for the replacement wind generation the transmission system would be able to maintain reliable performance and the Path 8 rating (2,200 MW) would be maintained. No additional reinforcements were identified.

**Study #3:**

**Conducted by NorthWestern Energy**

**EPA 111-D Consideration Retirement of CS units 1 and 2**

**April, 2015**

**Regional Electric Transmission Planning**

Study #3, conducted by NorthWestern Energy, also considered the closure of Colstrip Units 1 and 2. The study relied on either combined cycle gas, wind, or a combination of both types of generation as the replacement resources for the retired generation at Colstrip. The study investigated whether the mix of generation resources created impacts to the transmission system. The study also considered whether the maximum export of 2,200 MW for Path 8 (Montana to the Northwest) could be maintained.

The study found that the transmission system responded similarly for each of the varying mixes of replacement generation. As with the previous studies, the study also assumed that RAS for the replacement generation would be able to coordinate with the ATR RAS at Colstrip in order to maintain the path capacity of the existing system.

**Study #4:**

**Conducted by NorthWestern Energy**

**EPA 111-D Clean Power Plan Consideration Study: Retirement of All Coal-Fired Generation in Montana**

**November 2015**

Study #4, conducted by NorthWestern Energy investigated the closure of all four turbine-generator units at Colstrip. Additionally, the study included removal of all other coal fired



## Appendix H

generation within the NorthWestern Balancing Area (~2,500 MW total). The replacement generation came from a mix of gas, wind, or gas plus wind. The study also included a scenario that completely removed the 500 kV transmission system within Montana.

The study found that in the absence of the 500 kV system, there would need to be additional transmission reinforcement. The study identified reinforcement of the South of Great Falls cut-plane at a minimum. The scenario with the 500 kV system removed emphasizes one of the key findings for all of the study efforts: the 500 kV system is essential for service to customers in Montana.

Consistent with the other studies, Study #4 also demonstrated that RAS will be essential for the system to reliably maintain the existing transfer capability of the transmission system.

### **Consistency of Findings**

The findings from the studies should give cause for confidence to both the Transmission Owners and to developers seeking to integrate new resources into the Montana transmission system.

There should be minimal transmission reinforcements needed to successfully integrate new resources. There will be costs and reinforcement associated with the initial generation interconnection for these resources. While those costs could be substantial, they should be similar to interconnection costs on other parts of the transmission system including those beyond Montana.

RAS will be an essential element of allowing the transmission system to reliably maintain transfer capacity. As with interconnection, there will be costs associated with the RAS including coordination with the existing ATR at Colstrip or systematic new design, but these costs – by design – will avoid the time and cost barriers of developing expensive new linear transmission facilities.

## Appendix H

All of the studies were high level studies that relied on typical design data for the replacement generation as well as assumed performance of the transmission elements needed to integrate those resources. One of the concerns for developers in the MRDAP at the outset was the apparent uncertainty that the transmission system where they were seeking integration would not retain the system capability of the existing system in the face of retirement from the coal fired generation. While the Planning Committee did not embark on new studies, the Transmission Owners were able to demonstrate that when the time is right and there is clarity about replacement resources (and purchasers of the output from those new resources), the Transmission Owners will be able to complete the needed coordination of RAS (or implementation of new RAS design), demonstration of the transmission transfer capability commensurate with the existing system, and completion of generation interconnection requirements in a timely manner to support needed integration of renewable resources in Montana.

Links to each of these studies and paper follow below:

[2014-2015, Public Policy Consideration Study for NTTG](#)  
[2016-2017, Public Policy Consideration Study for NTTG](#)  
[NWE sponsored study, retirement of CS units 1 and 2](#)  
[NWE sponsored study, retirement of all coal in NEW's BA](#)  
[RNW sponsored whitepaper by Chuck Stigers](#)

### 8. Montana to Northwest



### 8. Montana to Northwest

Accepted Rating   
 Existing Rating   
 Other

<b>Location:</b>	The lines between western Montana and the Northwest US																				
<b>Definition:</b>	The lines involved in this path are the metered tie lines between NorthWestern Energy (NWMT) and Bonneville Power Administration (BPA), plus the metered tie lines between NWMT and Avista Corp. (AVA).  <table border="0"> <tr> <td></td> <td style="text-align: right;"><u>Metered End</u></td> </tr> <tr> <td>Broadview-Garrison #1 &amp; #2 500 kV lines</td> <td style="text-align: right;">Garrison</td> </tr> <tr> <td>Mill Creek-Garrison 230 kV line</td> <td style="text-align: right;">Garrison</td> </tr> <tr> <td>Anaconda (BPA)-Garrison 230 kV line</td> <td style="text-align: right;">Anaconda</td> </tr> <tr> <td>Ovando-Garrison 230 kV</td> <td style="text-align: right;">Garrison</td> </tr> <tr> <td>Placid Lake-Hot Springs 230 kV</td> <td style="text-align: right;">Hot Springs</td> </tr> <tr> <td>Rattlesnake 230/161 kV transformer</td> <td style="text-align: right;">230 kV</td> </tr> <tr> <td>Kerr-Kalispell 115 kV</td> <td style="text-align: right;">Kerr</td> </tr> <tr> <td>Thompson Falls-Burke 115 kV</td> <td style="text-align: right;">Burke</td> </tr> <tr> <td>Crow Creek-Burke 115 kV</td> <td style="text-align: right;">Burke</td> </tr> </table>		<u>Metered End</u>	Broadview-Garrison #1 & #2 500 kV lines	Garrison	Mill Creek-Garrison 230 kV line	Garrison	Anaconda (BPA)-Garrison 230 kV line	Anaconda	Ovando-Garrison 230 kV	Garrison	Placid Lake-Hot Springs 230 kV	Hot Springs	Rattlesnake 230/161 kV transformer	230 kV	Kerr-Kalispell 115 kV	Kerr	Thompson Falls-Burke 115 kV	Burke	Crow Creek-Burke 115 kV	Burke
	<u>Metered End</u>																				
Broadview-Garrison #1 & #2 500 kV lines	Garrison																				
Mill Creek-Garrison 230 kV line	Garrison																				
Anaconda (BPA)-Garrison 230 kV line	Anaconda																				
Ovando-Garrison 230 kV	Garrison																				
Placid Lake-Hot Springs 230 kV	Hot Springs																				
Rattlesnake 230/161 kV transformer	230 kV																				
Kerr-Kalispell 115 kV	Kerr																				
Thompson Falls-Burke 115 kV	Burke																				
Crow Creek-Burke 115 kV	Burke																				
<b>Transfer Limit:</b>	East to West: 2200 MW West to East: 1350 MW																				

## Acronyms

ATC	Available Transmission Capacity
ATR	Acceleration Trend Relay
AVA	Avista
BAA	Balancing Authority Area
BPA	Bonneville Power Administration
CAISO	California Independent System Operator
CF	Conditional Firm Transmission Service
CTS	Colstrip Transmission System
CUP-West	Colstrip Upgrade Project - West
DTC	Dynamic Transfer Capability
EI	Eastern Intertie
EIM	Energy Imbalance Market
FERC	Federal Energy Regulatory Commission
GASH	Garrison Ashe Project
kV	Kilovolt
LTF	Long Term Firm Transmission Service
M2W	Montana to Washington Project
MATL	Montana Alberta Transmission Line
MI	Montana Intertie
MIA	Montana Intertie Agreement
MVAR	Millivolt Ampere Reactive

Appendix J

MW	Megawatt
MRDAP	Montana Renewables Development Action Plan
NEPA	National Environmental Protection Act
NERC	North American Electricity Reliability Corporation
NTTG	Northern Tier Transmission Group
NWE	NorthWestern Energy
OASIS	Open Access Same-time Information System
OATT	Open Access Transmission Tariff
PAC	PacifiCorp
PGE	Portland General Electric
PNW	Pacific Northwest
PSH	PSH Mechanical and Electrical Design Consultancy
PTC	Production Tax Credit
PUD	Public Utility District
PWRX	Powerex
RAS	Remedial Action Scheme
RFP	Request for Proposal
RNW	Renewable Northwest
RPS	Renewable Portfolio Standard
RTO	Regional Transmission Organization
SAMTS	Service Across Multiple Transmission Systems
SNOPUD	Snohomish Public Utility District
SSR	Sub-synchronous Resonance
TO	Transmission Operator

Appendix J

TO	Transmission Operator
TP	Transmission Provider
TSEP	Transmission Service Request Study and Expansion Process
TSR	Transmission Service Request
TTC	Total Transmission Capacity
VAR	Volt Ampere Reactive
WAPA	Western Area Power Administration
WECC	Western Electricity Coordinating Council
WIST	Wind Integration Study Team
WOG	West of Garrison Cutplane
WOH	West of Hatwai Cutplane

