

# Verification by Equipment or End-Use Metering Protocol

September 2011



## **Verification by Equipment or End-Use Metering Protocol**

**Version 1.0**

**September 2011**

**Prepared for**

**Bonneville Power Administration**

**Prepared by**

**Research Into Action, Inc.**

**Quantum Energy Services & Technologies, Inc. (QuEST)**

**Stetz Consulting, LLC**

**Kolderup Consulting**

**Warren Energy Engineering, LLC**

**Left Fork Energy, Inc.**

**Schiller Consulting, Inc.**

**Contract Number 00044680**

# Table of Contents

- 1. Introduction.....1
  - 1.1. Purpose ..... 1
  - 1.2. Background ..... 1
- 2. Overview of Method .....3
  - 2.1. Description ..... 3
  - 2.2. Applicability ..... 4
    - 2.2.1. Constant Load, Timed Schedule (CLTS).....5
    - 2.2.2. Constant Load, Variable Schedule (CLVS) .....5
    - 2.2.3. Variable Load, Timed Schedule (VLTS).....6
    - 2.2.4. Variable Load, Variable Schedule (VLVS).....7
  - 2.3. Advantages of This Protocol ..... 7
  - 2.4. Disadvantages of This Protocol..... 8
- 3. Algorithms .....9
  - 3.1. Basic Procedure ..... 9
  - 3.2. Equations ..... 11
- 4. Measurement and Monitoring..... 17
  - 4.1. Constant Loads ..... 17
  - 4.2. Variable Loads ..... 17
  - 4.3. Timed Schedule ..... 19
  - 4.4. Variable Schedule ..... 19
- 5. Uncertainty ..... 21
  - 5.1. Constant Loads .....22
  - 5.2. Variable Loads .....22
  - 5.3. Timed Schedule ..... 23
  - 5.4. Variable Schedule ..... 23
- 6. Minimum Reporting Requirements..... 25
  - 6.1. Measurement and Verification Plan ..... 25
    - 6.1.1. Essential Elements of the Measurement and Verification Plan .....25
    - 6.1.2. M&V Plan Additional Elements.....26
    - 6.1.3. Documentation for BPA Database .....26

6.2. Savings Verification Report .....	27
6.2.1. General Verification Report Requirements Based on IPMVP.....	27
6.2.2. Additional Savings Verification Report Requirements .....	27
<b>7. Examples.....</b>	<b>31</b>
7.1. Example 1: Simple Pump Motor Replacement (Option B: ECM Reduces Load) .....	31
7.1.1. Overview .....	31
7.1.2. M&V Approach .....	31
7.1.3. Algorithm .....	33
7.1.4. Annual Savings .....	33
7.2. Example 2: Automobile Factory Paint Shop Exhaust Fans (Option A: ECM Reduces Schedule) .....	33
7.2.1. Overview .....	33
7.2.2. M&V Approach .....	33
7.2.3. Algorithm .....	35
7.2.4. Annual Savings .....	36
7.3. Example 3: Supply Fan IGV to VSD Conversion (Improved Fan Efficiency).....	36
7.3.1. Overview .....	36
7.3.2. M&V Approach .....	36
7.3.3. Algorithm .....	41
7.3.4. Annual Savings .....	41
7.4. Example 4: Constant Volume Blower to Variable Volume .....	42
7.4.1. Overview .....	42
7.4.2. M&V Approach .....	42
7.4.3. Algorithm .....	47
7.4.4. Annual Savings .....	47
<b>8. References and Resources.....</b>	<b>49</b>

# 1. Introduction

## 1.1. Purpose

This document presents a *Verification by Equipment or End-Use Metering Protocol*<sup>1</sup> as a complement to the Measurement and Verification (M&V) protocols used by the Bonneville Power Administration (BPA). The *Verification by Equipment or End-Use Metering Protocol* assists the engineer in isolating the equipment or end use to be targeted and selecting how many of what types of points to monitor or meter when it would not be cost-effective to monitor or meter all points, leading to specific M&V algorithms to verify the project's savings. It is intended for measures that change load or operating hours, or both load and hours. Savings can be large or small. The protocol can handle non-interactive measures and interactive measures in some circumstances. It is adherent with *IPMVP Options A and B*.

This document is one of many produced by BPA to direct M&V activities. The *Measurement and Verification (M&V) Protocol Selection Guide and Example M&V Plan* provides the region with an overview of all of BPA's M&V protocols, application guides, and reference guides, and gives direction as to the appropriate document for a given energy efficiency project. The document *Glossary for M&V: Reference Guide* defines terms used in the collection of BPA M&V protocols and guides.

Chapter 8 of this protocol provides full citations (and web locations, where applicable) of documents referenced.

## 1.2. Background

In 2009, BPA contracted with a team led by Research Into Action, Inc. to assist the organization in revising the M&V protocols it uses to assure energy savings for the custom projects it accepts from its customer utilities. The team has conducted two phases of research and protocol development under the contract, Number 00044680.

In the first phase, Research Into Action directed a team comprised of:

- Quantum Energy Services & Technologies, Inc. (QuEST), led by David Jump, Ph.D., PE and assisted by William E. Koran, PE;
- Left Fork Energy, Inc., the firm of Dakers Gowans, PE;
- Warren Energy Engineering, LLC, the firm of Kevin Warren, PE;
- Schiller Consulting, Inc., the firm of Steven Schiller, PE; and
- Stetz Consulting, LLC, the firm of Mark Stetz, PE.

---

<sup>1</sup> Hereinafter, *End-Use Metering Protocol*.

In the second phase, Research Into Action directed a team comprised of:

- David Jump, Ph.D., PE, William E. Koran, PE, and David Zankowsky of QuEST;
- Mark Stetz, PE, CMVP, of Stetz Consulting;
- Erik Kolderup, PE, LEED AP, of Kolderup Consulting; and
- Kevin Warren, PE, of Warren Energy Engineering.

The Research Into Action team was led by Jane S. Peters, Ph.D., and Marjorie McRae, Ph.D. Assisting Drs. Peters and McRae were Robert Scholl, Joe Van Clock, Mersiha Spahic, Anna Kim, Alexandra Dunn, Ph.D., and Kathleen Gygi, Ph.D.

For BPA, Todd Amundson, PE, directed the M&V protocol research and development activities. Mr. Amundson was working under the direction of Ryan Fedie, PE, and was assisted by BPA engineers. Mr. Amundson coordinated this work with protocol development work undertaken by the Regional Technical Forum. In addition, Mr. Amundson obtained feedback from regional stakeholders.

Dr. David Jump is the primary author of this *Verification by Equipment or End-Use Metering Protocol*; team members reviewed and provided guidance.

## 2. Overview of Method

### 2.1. Description

This protocol provides guidance to verify energy savings for energy conservation measures (ECMs) performed on equipment or end uses. The methods outlined are useful when the savings for an ECM are too small to be resolved with whole-building or facility energy meters, or for stand-alone equipment as may be found in the commercial, industrial, and agricultural sectors. It may also be applied to some new construction ECMs affecting equipment or end uses, as demonstrated in the BPA *End-Use Metering Absent Baseline Measurement: An M&V Protocol Application Guide*.<sup>2</sup> Verifying savings from ECMs that involve multiple pieces of equipment with interactions among multiple or complex energy flow paths are not good applications for this protocol.

The methods in this *End-Use Metering Protocol* are based on and extend the descriptions of retrofit isolation approaches found in *ASHRAE Guideline 14-2002* and its *Annex E for Retrofit Isolation*, as well as work from Texas A&M's Energy Systems Laboratory.<sup>3</sup> These documents focus on equipment or end uses directly affected by the ECM, such as fans, pumps, motors, lighting, chillers, and boilers typically found in facilities, whether as stand-alone equipment or as a component of a system.

In this protocol, the baseline energy use characteristics of the equipment or end use are broken down into load and hours-of-use components, and whether these components may be considered constant or variable. The impact of the ECM is used to determine the expected post-installation energy-use characteristics. When both baseline and post-installation energy-use characteristics are known, measurement and monitoring activities can be planned, implemented, and analyzed to determine savings.

Depending on available resources and M&V budget constraints, this method may be used in an *IPMVP*<sup>4</sup> *Option A* or an *Option B* approach. *Option A* is a *key parameter measurement* approach, in which only the most unknown or uncertain quantities are measured while other parameters may be reliably estimated. Under *Option B*, *all parameters* are measured.

To alleviate strain on budgets and resources, this protocol is flexible to allow use of readily available information, such as nameplate data, equipment specifications, and manufacturer's performance curves. This information may be validated with one-time spot measurements or more rigorously with multiple measurements over the equipment's performance range, depending on project requirements.

---

<sup>2</sup> Hereinafter, *Absent Baseline Application Guide*.

<sup>3</sup> For example: *Review of Methods for Measuring and Verifying Savings from Energy Conservation Retrofits to Existing Buildings*, Haberl, J.S. and C. H. Culp, Energy Systems Laboratory.

<sup>4</sup> *International Performance Measurement and Verification Protocol (IPMVP)*.

The Option A approach provides a means to apply this protocol to new construction ECMs. In new construction, there is no baseline equipment to measure load or hours-of-use. However, these parameters may be estimated using the manufacturer’s specifications, well-founded and documented engineering assumptions, or relevant codes and standards that describe minimum performance levels for new buildings and systems. The BPA *Absent Baseline Application Guide* demonstrates the appropriate method.

Implementing this protocol requires collecting data for important parameters, such as operating hours, fuel use, energy, demand, fluid flow, or temperatures. Sometimes these data are available on a facility energy management system, but frequently stand-alone data loggers must be deployed for some period. Collection of field data is a time and cost consideration that must be addressed when implementing this protocol.

## 2.2. Applicability

This protocol is applicable for equipment or end uses that meet the following criteria:

- ➔ **Loads** – such as air or water flow, Btu/h, cooling tons, conveyance delivery rates, and so on – that may be isolated and measured (or estimated if using an Option A approach, see below) and their relationships to the energy use rates (i.e., kW) are known or may be developed through engineering and statistical relationships.
- ➔ **Variable equipment operating schedules** may be represented accurately by binned load frequency distributions (see below).
- ➔ **Energy flows** in and out of measurement boundaries are few and/or straightforward to account for through estimations or measurements, and there are negligible interactive effects or interactive effects are intentionally left out of the M&V scope of work.
- ➔ **End uses** that include multiple pieces of equipment but have energy characteristics similar to a single piece of equipment which is applicable under this protocol – for example, a constant volume air handling system where both supply and return fans are within the measurement boundary.

As described above, the energy-use characteristics of equipment or end uses are defined according to their load and hours-of-use components, and whether they are constant or variable. This provides the basis for which measurements and estimations may be made. This protocol is applicable to equipment or end uses that can be classified according these definitions. For brevity, the term *equipment* will be used, although the phrase *equipment and end uses* may be used interchangeably. Following are descriptions of the four load and hours-of-use categories: *constant load, timed schedule* (CLTS); *constant load, variable schedule* (CLVS); *variable load, timed schedule* (VLTS); and *variable load, variable schedule* (VLVS).<sup>5</sup>

---

<sup>5</sup> We use slightly different terms than the naming convention in ASHRAE *Guideline 14-2002 Section 6.2.3*. The *Guideline’s* terms for these same conditions are: *Constant Load, Constant Use; Constant Load, Variable Use; Variable Load, Constant Use; and Variable Load, Variable Use*.

### 2.2.1. Constant Load, Timed Schedule (CLTS)

CLTS includes equipment with constant load and constant hours-of-use, as depicted in Figure 2-1. The degree to which a load or hours-of-use is constant may be defined by the user; ASHRAE's *Guideline 14-2002* indicates a 5% limit in the variance<sup>6</sup> of load or hours-of-use to be considered constant. In this category, the measured energy use rate (kW) is often used directly in calculations, after verifying that the load is constant.

**Figure 2-1: Load and Hours-of-Use Characteristics of CLTS Equipment**

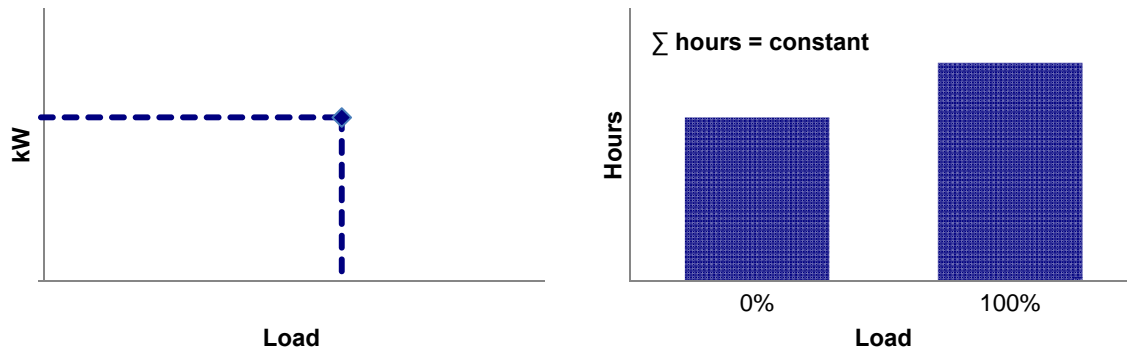

Examples of equipment with CLTS operating characteristics include:

1. Lighting under time-clock control
2. Constant volume air handling units under time-clock control (fan energy savings only)
3. Water treatment plant pump operation (24/7)
4. Constant-speed computer room air-handling unit fan operation (24/7)
5. Water fountain pumps

### 2.2.2. Constant Load, Variable Schedule (CLVS)

CLVS includes equipment with constant load and varying hours-of-use, as depicted in Figure 2-2. There are two bins in the load frequency distribution; however, the total number of hours in each bin is unknown.

<sup>6</sup> For the purposes of this protocol, this variance is defined as the *coefficient of variation of the standard deviation*:  $CV(STD)$ . It is calculated by  $CV(STD) = \sigma/\bar{x}$ , where  $\sigma$  = standard deviation about the mean value, and  $\bar{x}$  = mean of measured values.

**Figure 2-2: Load and Hours-of-Use Characteristics for CLVS Equipment**

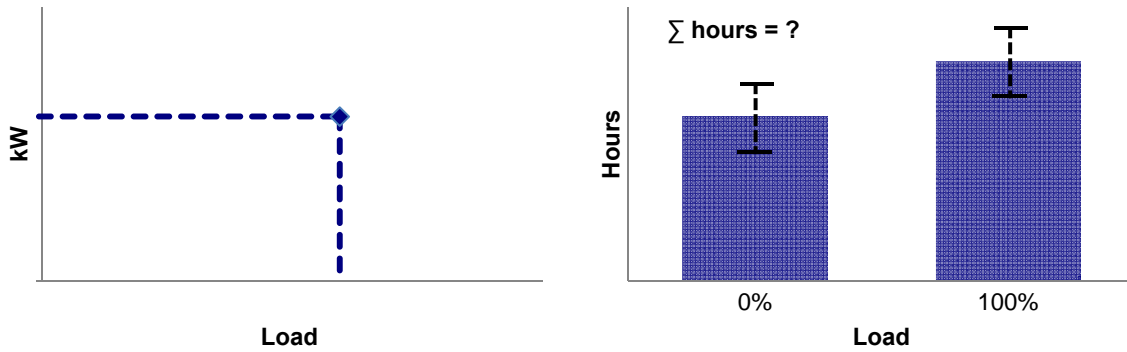

Examples of equipment with CLVS operating characteristics include:

1. Elevators
2. Lighting under occupancy-sensor control
3. Constant-speed cooling tower fan operation (schedule varies with temperature)
4. Hot water or chilled water pumping, no VFD (schedule varies with boiler/chiller operation)
5. Auto factory paint-shop exhaust fans

### 2.2.3. Variable Load, Timed Schedule (VLTS)

VLTS includes equipment with varying load and constant hours-of-use, as depicted in Figure 2-3. While the total number of operation hours is constant, the equipment may spend a fixed number of hours at different loads; this is the basis of the multiple percentage load bins in the load frequency distribution (chart on right-hand side). The load curve (chart on left hand side) may be obtained from engineering models, manufacturer’s performance curves or data, or empirical relationships (regressions) developed from monitored data. The energy use rate (kW) is a function of the load and the load itself may be a function of other parameters.

**Figure 2-3: Load and Hours-of-Use Characteristics for VLTS Equipment**

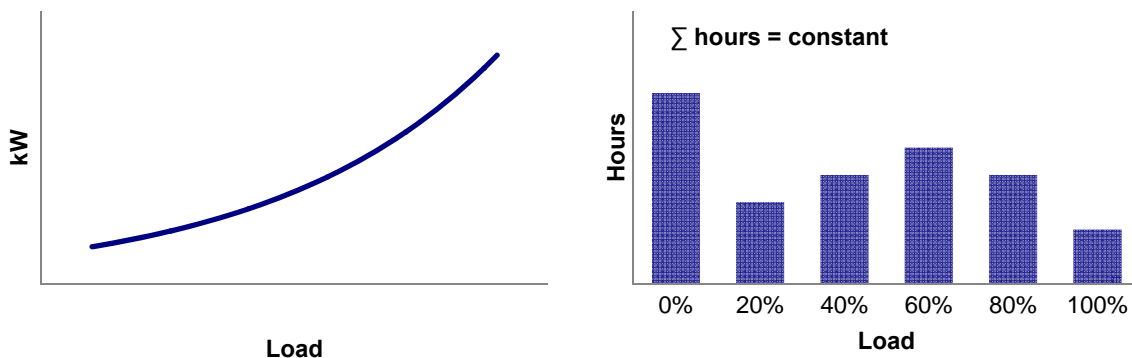

Examples of equipment with VLTS operating characteristics include:

1. Bi-level lighting under time-clock control at each level
2. Variable volume air-handling unit fans under time-clock control for specific flow levels
3. Wastewater treatment plant air blowers maintaining constant dissolved oxygen level (24/7)
4. Industrial 2-speed cooling tower fan operation (speeds controlled by process)
5. Computer room air-conditioning unit operation (condenser unit on roof)

### 2.2.4. Variable Load, Variable Schedule (VLVS)

VLVS includes equipment with varying load and varying hours-of-use, as depicted in Figure 2-4. In this case, the total number of hours of operation and the number in each percentage load bin are unknown. Load curves may be developed as described above for VLTS.

**Figure 2-4: Load and Hours-of-Use Characteristics for VLVS Equipment**

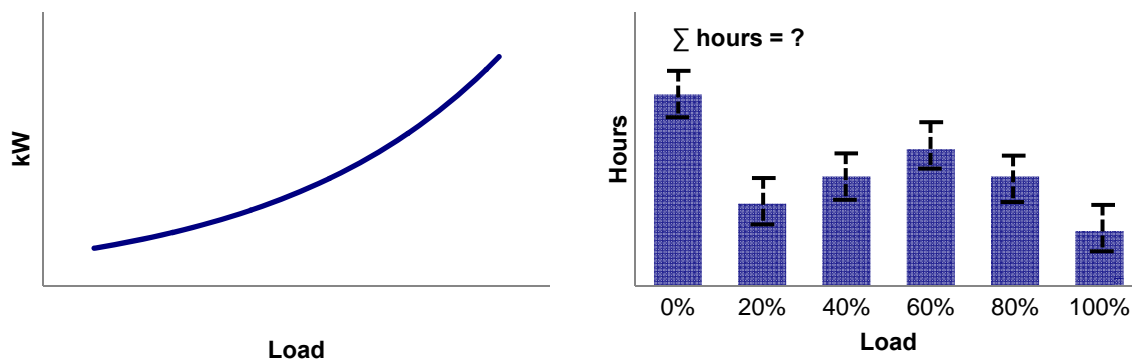

Examples of equipment with VLVS operating characteristics include:

1. Variable air volume air handling unit (AHU) under thermostat control
2. Hot-water boiler serving reheat coils in zones
3. Chilled water system maintaining a chilled water supply set point reset schedule
4. Industrial compressed-air system variable frequency drive (VFD) compressor
5. VFD controls on an irrigation pump

## 2.3. Advantages of this Protocol

Use of this *End-Use Metering Protocol* has several advantages:

- ➔ The protocol enables verification of ECMs on specific equipment through the use of data and information that was used to develop the savings estimates.

- ➔ When the resolution of the project's savings against the whole-building or meter baseline must be significant, this protocol is more advantageous over whole-building methods.
- ➔ Under Option A, this protocol allows use of the abundant technical information from manufacturers, such as equipment performance curves, design and nameplate information, and so on.
- ➔ Many of the measurements required by this protocol can be achieved in a relatively short time period.
- ➔ The methods described here may be applied to more complicated systems, as long as their operational characteristics fall into the categories identified above.
- ➔ The methods allow uncertainty in the savings estimates to be quantified, should that be a project requirement.

## 2.4. Disadvantages of this Protocol

This protocol is not appropriate for multiple ECMs installed throughout a building, where a whole-building approach is more appropriate. The methods described here do not account for energy interactions, such as heating savings from a lighting retrofit project. Projects with highly randomized load and schedule characteristics may not be appropriate for this methodology.

## 3. Algorithms

### 3.1. Basic Procedure

Characterizing the equipment's energy-use properties into constant or variable load and hours-of-use facilitates development of the M&V Plan for each project. The fundamental procedure is:

1. Identify which of the four categories – CLTS, VLTS, CLVS, or VLVS – best represents the baseline equipment's load and hours-of-use characteristics.
2. Determine the impact the ECM will have on the equipment's load or hours-of-use. Determine if it will change the load or hours-of use, or change them from constant to variable.
3. Identify which of the four categories best represents the anticipated post-installation equipment's load and hours-of-use characteristics.
4. Identify the most appropriate equations to be used to determine energy savings
5. Determine the relationships between load and hours-of-use terms in the energy savings equation and other parameters, such as temperature, air or water flow, pressure, and so on.
6. Identify and collect the required data in the respective baseline and post-implementation periods.
7. Calculate energy savings using equations and tips as provided below.

Depending on various factors, such as available monitoring resources, savings magnitude, required accuracy, and so on, an *IPMVP Option A Retrofit Isolation: Key Parameter Measurement* or *Option B Retrofit Isolation: All Parameter Measurement* methodology may be used.

Under Option A, key parameters for measurement are identified and the other parameters to the savings calculation may be estimated based on reliable sources. The key parameters to be measured are normally the most uncertain or unknown parameters. Reliable sources include past measurements, manufacturer specifications and performance curves, lighting wattage tables, and so on. Note that in the categories defined above, load and hours-of-use may depend on many other parameters, both constant and time-varying, and Option A allows judicious selection among these parameters for measurement.

As a simple example, an ECM consists of a lighting occupancy sensor controlling lighting in a general office area. The fixture wattage (load) may be estimated based on a lighting wattage table, but the actual hours of operation of the fixture are measured with lighting status loggers.

Note that Option A does *not* allow both load and hours-of-use parameters (including all their sub-parameters) to be estimated; key parameters must be identified and *measured*. (See below for recommended measurement strategies.)

Under Option B, both load and hours-of-use parameters must be measured. The amount and duration of metering depends on the equipment’s load and hours-of-use characteristics. For variable load or hours-of-use systems, it is important to capture data over as much of the operation range as possible. Energy consumption is usually expressed on an annual basis. However, variable load or variable hours-of-use equipment often range through their normal operating cycles over much shorter time periods. Unless the required data is collected for other reasons, it is costly and impractical to monitor data for a full year. Results from shorter monitoring periods must be extrapolated to determine annual use. This introduces uncertainty into the calculations, especially if there are seasonal effects on energy use. A general rule to minimize uncertainty is to collect as much data as possible to lessen the amount of extrapolation required.

Table 3-1 lists the suggested sources of data for each of the four categories, showing how some parameters may be estimated under Option A and measured under Option B. As stated above, only one parameter may be estimated under Option A; the other parameter must be measured. The measurement strategies under Option B in the table may be used for these purposes.

**Table 3-1: Option A and Option B Data Sources and Measurement Strategies by Category**

Option	Parameter	Data Source / Measurement Strategy
<b>Constant Load, Timed Schedule (CLTS)</b>		
<b>Option A</b>	Load	Nameplate information Equipment specifications
	Hours-of-Use	Facility/equipment operation logs Interviews with facility operators
<b>Option B</b>	Load	Spot measurement Average of multiple measurements
	Hours-of-Use	Data logger to record equipment operation status EMS trend on equipment status
<b>Variable Load, Timed Schedule (VLTS)</b>		
<b>Option A</b>	Load	Manufacturer’s equipment performance curve Validation of manufacturer’s curve with spot measurement of one point to validate curve Use of ambient temperatures as a substitute for load
	Hours-of-Use	Facility/equipment operation logs Interviews with facility operators Hours in ambient temperature bins
<b>Option B</b>	Load	Measurements of load and energy variables over the entire range of operation, development of in-situ performance curve
	Hours-of-Use	Use of logged or trended load data to populate bins in the load frequency distribution

Continued

Option	Parameter	Data Source / Measurement Strategy
<b>Constant Load, Variable Schedule (CLVS)</b>		
<b>Option A</b>	Load	Nameplate information Equipment specifications
	Hours-of-Use	Facility/equipment operation logs Interviews with facility operators
<b>Option B</b>	Load	Spot measurement Average of multiple measurements
	Hours-of-Use	Use of loggers or EMS trends to monitor hours-of-operation over representative periods
<b>Variable Load, Variable Schedule (VLVS)</b>		
<b>Option A</b>	Load	Manufacturer's equipment performance curve Validation of manufacturer's curve with spot measurement of one point to validate curve Use of ambient temperatures as proxy for load
	Hours-of-Use	Facility/equipment operation logs Interviews with facility operators If load driven by ambient temperature, use binned weather data
<b>Option B</b>	Load	Measurements of load and energy variables over the entire range of operation, development of in-situ performance curve
	Hours-of-Use	Use of logged or trended load data to populate bins in the load frequency distribution

## 3.2. Equations

It is often not necessary to repeat baseline data collection activities in the post-implementation period. In many circumstances, only one parameter must be measured in the baseline period. For example, in a CLTS system where the equipment's power will be reduced, such as in a lighting fixture replacement, it is only necessary to measure the equipment's power in the baseline period and the (reduced) power and hours of operation in the post-installation period, since the hours of operation do not change. Conversely, the hours of operation may be measured in the baseline period. Savings are calculated based on:

■ **Equation 1:**  $kWh_{saved} = (kW_{base} - kW_{post})HRS_{post}$

where:  $kW$  = electric power demand

$kWh$  = electric energy use

$HRS$  = hours of operation

$base$  = indicates parameter measured (or estimated) in baseline period

$post$  = indicates parameter measured (or estimated) in post-installation

$saved$  = indicates quantity saved

The impact of the ECM on the characteristics of the equipment’s load or hours-of-use must be understood prior to planning the data collection and analysis activities of the M&V plan. This can save time and reduce requirements for data collection devices in either the baseline or the post-installation periods.

Table 3-2 through Table 3-5 contain energy savings equations that may be used for each combination of load and schedule category. Within each table, the impact of the ECM on the load, hours-of-use, or both, determines the potential energy savings equations that may be used. These equations show important parameters to measure in the respective baseline and post-installation periods. Please note that these are not an exhaustive set of equations; depending on the equipment and its energy-use characteristics, the equations may take on other forms than those listed. Additional parameters shown in Table 3-2 through Table 3-5 include:

- $Q$  = equipment load such as air or water flow, cooling tons, conveyance delivery rate, and so on
- $Eff$  = equipment normalized power, expressed as kW/ton, kW/cfm, and so on

Note that the energy rate  $kW$ , load  $Q$ , and efficiency  $Eff$  are often functions of other parameters. For example, cooling tons are a function of the supply and return water temperatures, and flow rates, each of which may be measured. These relationships may be obtained from engineering definitions and principles, or may be obtained from empirical relationships, such as from statistical regression techniques. (See the companion *BPA Regression for M&V: Reference Guide*<sup>7</sup> for more information.)

IPMVP-adherent M&V requires that baseline and post-installation energy use be brought to the same set of conditions, in order to make a fair determination of savings. When the energy rate, load, and efficiency are expressed in terms of measureable independent parameters, the functional forms of the relationships allow savings to be calculated from the same set of conditions (Table 3-2).

**Table 3-2: Constant Load, Timed Schedule (CLTS) Equations**

ECM Impact	Basic Savings Equation
<b>Changes Load</b>	$kWh_{saved} = (kW_{base} - kW_{post}) \cdot HRS_{post}$
	$kWh_{saved} = (Eff_{base} - Eff_{post}) \cdot Q_{base} \cdot HRS_{base}$
	$kWh_{saved} = (1 - Eff_{post} / Eff_{base}) \cdot kW_{base} \cdot HRS_{base}$
	$kWh_{saved} = (Eff_{base} - Eff_{post}) \cdot Q_{post} \cdot HRS_{post}$
	$kWh_{saved} = (Eff_{base} / Eff_{post} - 1) \cdot kW_{post} \cdot HRS_{post}$

Continued

<sup>7</sup> Hereinafter, *Regression Reference Guide*.

ECM Impact	Basic Savings Equation
<b>Changes Hours-of-Use</b>	$kWh_{saved} = kW_{base} \cdot (HRS_{base} - HRS_{post})$ $kWh_{saved} = Eff_{base} \cdot Q_{base} \cdot (HRS_{base} - HRS_{post})$ $kWh_{saved} = Eff_{post} \cdot Q_{post} \cdot (HRS_{base} - HRS_{post})$
<b>Changes Load and Hours-of-Use</b>	$kWh_{saved} = kW_{base} \cdot HRS_{base} - kW_{post} \cdot HRS_{post}$ $kWh_{saved} = (Eff_{base} \cdot HRS_{base} - Eff_{post} \cdot HRS_{post}) \cdot Q_{post}$
<b>Changes Load from Constant to Variable</b> $HRS = \sum_i HRS_i$	$kWh_{saved} = kW_{base} \cdot HRS - \sum_i [kW_{post,i} \cdot HRS_i]$ $kWh_{saved} = Eff_{base} \cdot Q_{base} \cdot HRS - \sum_i [Eff_{post,i} \cdot Q_{post,i} \cdot HRS_{post,i}]$
<b>Changes Hours-of-Use from Constant to Variable</b> $HRS_{base} \neq HRS_{post}$ $HRS_{post} = \sum_i HRS_{post,i}$	$kWh_{saved} = kW_{base} \cdot HRS_{base} - kW_{base} \sum_i HRS_{post,i}$ $kWh_{saved} = Eff_{base} Q_{post} HRS_{base} - Eff_{base} Q_{post} \sum_i HRS_{post,i}$
<b>Changes both Load and Hours-of-Use from Constant to Variable</b>	$kWh_{saved} = kW_{base} HRS_{base} - \sum_i [kW_{post,i} \cdot HRS_{post,i}]$ $kWh_{saved} = Eff_{base} \cdot Q_{base} \cdot HRS_{base} - \sum_i [Eff_{post,i} \cdot Q_{post,i} \cdot HRS_{post,i}]$

**Table 3-3: Variable Load, Timed Schedule (VLTS) Equations**

ECM Impact	Basic Savings Equation
<b>Changes Load</b> $\sum_i HRS_{base,i} = \sum_i HRS_{post,i}$	$kWh_{saved} = \sum_i [kW_{base,i} \cdot HRS_{base,i} - kW_{post,i} \cdot HRS_{post,i}]$ $kWh_{saved} = \sum_i [(Eff_{base,i} \cdot HRS_{post,i} - Eff_{post,i} \cdot HRS_{post,i}) \cdot Q_{post,i}]$
<b>Changes Hours-of-Use</b>	$kWh_{saved} = \sum_i [kW_{base,i} \cdot (HRS_{base,i} - HRS_{post,i})]$ $kWh_{saved} = \sum_i [Eff_{base,i} \cdot Q_{base,i} \cdot (HRS_{base,i} - HRS_{post,i})]$
<b>Changes Load and Hours-of-Use</b>	$kWh_{saved} = \sum_i [kW_{base,i} \cdot HRS_{base,i} - kW_{post,i} \cdot HRS_{post,i}]$ $kWh_{saved} = \sum_i [(Eff_{base,i} \cdot HRS_{base,i} - Eff_{post,i} \cdot HRS_{post,i}) \cdot Q_{post,i}]$

Continued

ECM Impact	Basic Savings Equation
<b>Changes Hours-of-Use from Constant to Variable</b>	$kWh_{saved} = \sum_i [kW_{base,i} \cdot (HRS_{base,i} - HRS_{post,i})]$ $kWh_{saved} = \sum_i [Eff_{base,i} \cdot Q_{base,i} \cdot (HRS_{base,i} - HRS_{post,i})]$

**Table 3-4: Constant Load, Variable Schedule (CLVS) Equations**

ECM Impact	Basic Savings Equation
<b>Changes Load</b>	$kWh_{saved} = (kW_{base} - kW_{post}) \cdot HRS_{base}$ $kWh_{saved} = (Eff_{base} - Eff_{post}) \cdot Q_{base} \cdot HRS_{base}$ $kWh_{saved} = (1 - Eff_{post} / Eff_{base}) \cdot kW_{base} \cdot HRS_{base}$ $kWh_{saved} = (Eff_{base} - Eff_{post}) \cdot Q_{post} \cdot HRS_{post}$ $kWh_{saved} = (Eff_{base} / Eff_{post} - 1) \cdot kW_{post} \cdot HRS_{post}$
<b>Changes Hours-of-Use</b>	$kWh_{saved} = kW_{base} \cdot (HRS_{base} - HRS_{post})$ $kWh_{saved} = Eff_{base} \cdot Q_{base} \cdot (HRS_{base} - HRS_{post})$ $kWh_{saved} = Eff_{post} \cdot Q_{post} \cdot (HRS_{base} - HRS_{post})$
<b>Changes Load and Hours-of-Use</b>	$kWh_{saved} = kW_{base} \cdot HRS_{base} - kW_{post} \cdot HRS_{post}$ $kWh_{saved} = (Eff_{base} \cdot HRS_{base} - Eff_{post} \cdot HRS_{post}) \cdot Q_{post}$
<b>Changes Load to from Constant to Variable</b> $HRS_{base} = \sum_i HRS_{post,i}$	$kWh_{saved} = kW_{base} \cdot HRS_{base} - \sum_i [kW_{post,i} \cdot HRS_{post,i}]$ $kWh_{saved} = Eff_{base} \cdot Q_{post} \cdot HRS_{base} - \sum_i [Eff_{post,i} \cdot Q_{post,i} \cdot HRS_{post,i}]$

**Table 3-5: Variable Load, Variable Schedule (VLVS) Equations**

ECM Impact	Basic Savings Equation
<b>Changes Load</b>	$kWh_{saved} = \sum_i [(kW_{base,i} - kW_{post,i}) \cdot HRS_{post,i}]$ $kWh_{saved} = \sum_i [(Eff_{base,i} - Eff_{post,i}) \cdot Q_{post,i} \cdot HRS_{post,i}]$

Continued

ECM Impact	Basic Savings Equation
<b>Changes Hours-of-Use</b>	$kWh_{saved} = \sum_i [kW_{base,i} \cdot (HRS_{base,i} - HRS_{post,i})]$ $kWh_{saved} = \sum_i [Eff_{base,i} \cdot Q_{post,i} \cdot (HRS_{base,i} - HRS_{post,i})]$
<b>Changes Load and Hours-of-Use</b>	$kWh_{saved} = \sum_i [kW_{base,i} \cdot HRS_{base,i}] - \sum_i [kW_{post,i} \cdot HRS_{post,i}]$ $kWh_{saved} = \sum_i [Eff_{base,i} \cdot Q_{post,i} \cdot HRS_{base,i}] - \sum_i [Eff_{post,i} \cdot Q_{post,i} \cdot HRS_{post,i}]$



## 4. Measurement and Monitoring

Application of these methods, either under an Option A or Option B approach, requires some measurements or monitoring of load or schedule characteristics. This chapter provides background information to help users develop measurement strategies for their projects.

By convention, savings are reported on an annual basis. Adherence with IPMVP requires that savings be reported only for periods in which measurements are made. It is rarely cost-effective to measure load and hours-of-use parameters for an entire year. Instead, results from shorter time periods are extrapolated. As described previously, the more data that is collected over longer time periods, the less extrapolation that is required. However, any savings result based on such extrapolations is not IPMVP-adherent.

As the energy savings equations show, separating out the load and schedule parameters allows them to be separately determined. Once it is determined that an Option A or an Option B method will be used, the parameters to be monitored are identified.

- ➔ Generally, measurements that characterize the loads do not need to be measured or monitored over an entire year; however, they do need to be measured over a majority of their range of operations.
- ➔ Hours-of-use should be measured over the entire year to be adherent with IPMVP requirements for buildings; however, developing the bin-hours of the load frequency distribution over a representative period and extrapolating to annual totals is a generally accepted practice.

The following sections provide examples of how constant and variable loads may be developed, and how hourly bins may be populated in the load frequency distributions.

### 4.1. Constant Loads

As described above, the energy-use rate (kW) for constant-loaded systems may be directly measured with spot measurements or quantified by an average of multiple measurements over a short time period. If the variation in the data (CV) is less than 5%, then the average value can be considered the constant rate of energy use. Examples of constant-loaded systems, where the rate of energy use is directly measured, include lighting fixture or circuit wattages, and constant-loaded pumps and fans.

### 4.2. Variable Loads

Several terms in the equations above require relationships between energy-use rate and load, and between load and other parameters. There are several techniques that may be used to develop these relationships:

- ➔ Obtain the manufacturer's curve for equipment and use measurements to validate multiple points on the curve.

- ➔ Install monitoring devices to measure power and load, and monitor each as equipment is forced through its range of loads by adjusting control settings.
- ➔ Install monitoring devices to measure power and load, or use control-system trending, and monitor the equipment over time as the equipment is operated through its range.

Each of the above techniques provides a set of data that can be used to develop or validate a relationship between the load and energy-use rate (power). These relationships may be developed from engineering principles or empirically by regression. (Please see *Regression Reference Guide* for further information.)

As an example of developing a direct relationship between a load and energy-use rate, Figure 4-1 shows the relationship derived between fan speed (percent) and fan kW for a variable speed supply fan in a university computer science building. The data were collected over a two-week period from temporarily installed kW loggers and corresponding trends of fan speed from the building’s energy management system. The data were plotted in a scatter plot and a cubic polynomial relationship was fitted to the data using the least squares technique – which is common in most spreadsheet applications.

**Figure 4-1: Curve Fit of Fan kW as a Function of Fan Speed**

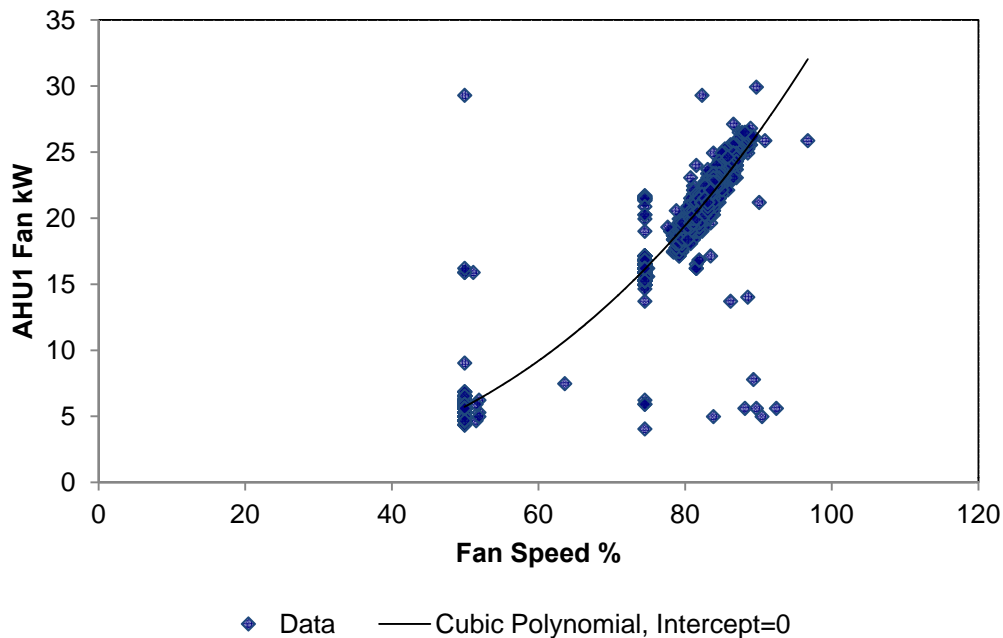

### 4.3. Timed Schedule

Quantifying constant hours-of-use for either constant- or variable-load equipment is generally a straightforward process. For constant loads, the number of hours that the equipment is operating must be verified. For variable loads, the number of hours within predefined load bins must be verified. A representative time period is selected over which the operating hours are measured. The monitoring period can be considered representative of the entire year if the relative distribution of hours among the bins is the same in the monitoring period as for the entire year.

As a descriptive example for a constant-load project, if an office building has regular occupancy hours that are the same all year, then a measurement period of one month may be representative of the entire year's operations. For a lighting retrofit project (assuming lighting on the interior of a building in spaces away from daylight), status loggers may be installed to determine the lighting operation hours for each day of the week. After a month of status data is collected, the average hours of operation of each day – whether it is a weekday, weekend, or holiday – is determined, and the total annual hours of operation are calculated by multiplying each day's average by the number of occurrences of those daytypes in the year (a number close to 52 in most cases), and then by adding them together.

The previous example's framework may also be used for variable-load projects with timed schedules. Consider a computer room air conditioning (CRAC) unit that operates to maintain the data center's space temperature at 70° F throughout the year. It is a split system with a condenser unit on the roof; hence, it is variable load, as the AC unit must push heat to the ambient air throughout the seasons. Since the CRAC unit duty cycles more or less frequently to meet load requirements, and the power of each on-cycle can be measured, the average hourly power can be used to develop a regression with the ambient temperature.

Ambient temperatures and CRAC unit status signals are trended in an energy-management system. Ambient temperature bins of 5° F are defined and the number of hours within each bin is determined for a defined monitoring period. The period selected should be representative of the entire year. This means that the collected data must span as much of the operating range as possible, preferably over 90% of the range. With such representative data, then the annual operation hours of the CRAC unit in each load bin may be quantified by multiplying the bin's measurement period operation hours by the ratio of annual operation hours divided by the measurement-period operation hours.

The above two examples demonstrate that the characteristics of each project's equipment has unique characteristics and insights that help determine appropriate measurement scenarios. These insights can be used to develop cost-effective monitoring plans.

### 4.4. Variable Schedule

Quantifying variable hours-of-use for either constant- or variable-load equipment is more dependent on the characteristics of each project's equipment. The hours-of-use may be dependent on some driving variable. For example, a chilled-water pump may have more hours-of-use in the warmer summer months than in winter months, or a building's lighting schedule may vary with the addition of daylight controls, having shorter hours of operation in summer than in winter. It is also possible that a representative period may not exist.

Regression techniques to determine the dependency of hours-of-use on an independent parameter may be used. For example, the daily hours-of-use of the chilled water pump may show a good relationship with average daily temperature. If a regression technique is used, the monitoring period should capture data over the entire range of daily pump operations and daily temperatures. This period may be less than one year. Annual energy use and savings may then be determined by extrapolation using ambient temperature data from a typical mean year weather file. The standard error of the regression may be used in savings uncertainty calculations.

## 5. Uncertainty

The methods described in this protocol provide a framework to determine uncertainties in the load and schedule parameters, as well as the estimated savings uncertainty. Because BPA generally does not require rigorous estimates of savings uncertainty, this chapter will only present general concepts and demonstrate how savings uncertainties may be calculated using this protocol's load and schedule framework.

The term *uncertainty* is used when the actual value of something that is measured, or estimated from an equation, is unknown. It is a probabilistic statement about how often a specified range around the predicted value contains the actual value. The *confidence limits* define that specified range that has a certain probability of containing the true value. For example, a savings uncertainty statement may say that the savings are “500 kWh,  $\pm 5\%$  at the 95% confidence level.” This means that with a probability of 95%, the range of 475 to 525 kWh includes the true value. A statement of “500 kWh,  $\pm 5\%$  at the 68% confidence level” means that with a probability of 68%, the range of 475 to 525 kWh includes the true value. Contrast the term *uncertainty* with the term *error*. Error is the difference between a measured or predicted value and the true value. A statement of the accuracy of a prediction (such as  $\pm 5\%$ ) is meaningless without an accompanying statement of its confidence level (such as 90%). (Refer to the *Glossary for M&V: Reference Guide* – a companion document to this protocol – and to statistical and experimental methods handbooks to find more information on the definitions of *uncertainty*, *error*, and *confidence limits*.<sup>8</sup>)

Since M&V is based on measurements, physical and statistical modeling, and predictions, rigorous uncertainty analysis begins from the physical measurements of the data, through equations, to a final savings estimate. The rules of error propagation may be applied, provided that the sample errors have been generated at the same confidence levels. Standard error propagation equations are shown below. In these equations,  $a$  and  $b$  are two values being combined,  $x$  is the result,  $k$  is a constant, and the symbol  $\Delta$  represents the error in the value. Also,  $\Delta a$  is the absolute error of the value  $a$ , and  $\Delta a/a$  is its relative error.

- **Addition and subtraction:**  $x = a + b$  ;  $\Delta x^2 = \Delta a^2 + \Delta b^2$
- **Multiplication and division:**  $x = a \cdot b$  ;  $(\Delta x/x)^2 = (\Delta a/a)^2 + (\Delta b/b)^2$
- **Exponential:**  $x = k \cdot a^k$  ;  $\Delta x = k \cdot \Delta a \cdot a^{k-1}$  and  $x = a^{1/k}$  ;  $\Delta x = \Delta a \cdot a^{1/k} / ka$

The following sections provide general insight on how uncertainties in the load and hours-of-use parameters may be determined. A more thorough description of uncertainty estimation is beyond the scope of this protocol. Refer to *ASHRAE Guideline 14 Annex B, Determination of Savings Uncertainty* for a more detailed discussion of savings uncertainty.

---

<sup>8</sup> Several good sources exist. On the Internet, please consult the *Engineering Statistics Handbook (NIST/SEMATECH e-Handbook of Statistical Methods)*.

## 5.1. Constant Loads

Constant loads may be characterized by a one-time measurement, or an average of several measurements. If a one-time measurement is used, the measurement instrument's rated or calibrated accuracy is the only available information upon which to obtain an uncertainty estimate. *ASHRAE Guideline 2-2010*<sup>9</sup> recommends using a 95% confidence limit with instrument accuracies. For calibrated instruments, their accuracy is generally an indication of its random error, bias error – bias in the measurement process – having been eliminated by calibration.

An average of multiple measurements of the same parameter with a calibrated instrument reduces the overall uncertainty of the parameter's estimated value. For multiple measurements, the *standard deviation* may be used as the uncertainty estimate. This quantity must be calculated to determine whether the load may be characterized as constant. It is part of the coefficient of variation (CV) and must be less than 5%. Please refer to the suggested statistical references to determine confidence limits about the average value.

## 5.2. Variable Loads

Variable loads are represented by an equation, which may be derived from physical principles or from statistical modeling. Figure 5-1 shows upper and lower confidence limits about the regression line.

**Figure 5-1: Regression Line showing Upper and Lower Confidence Limits**

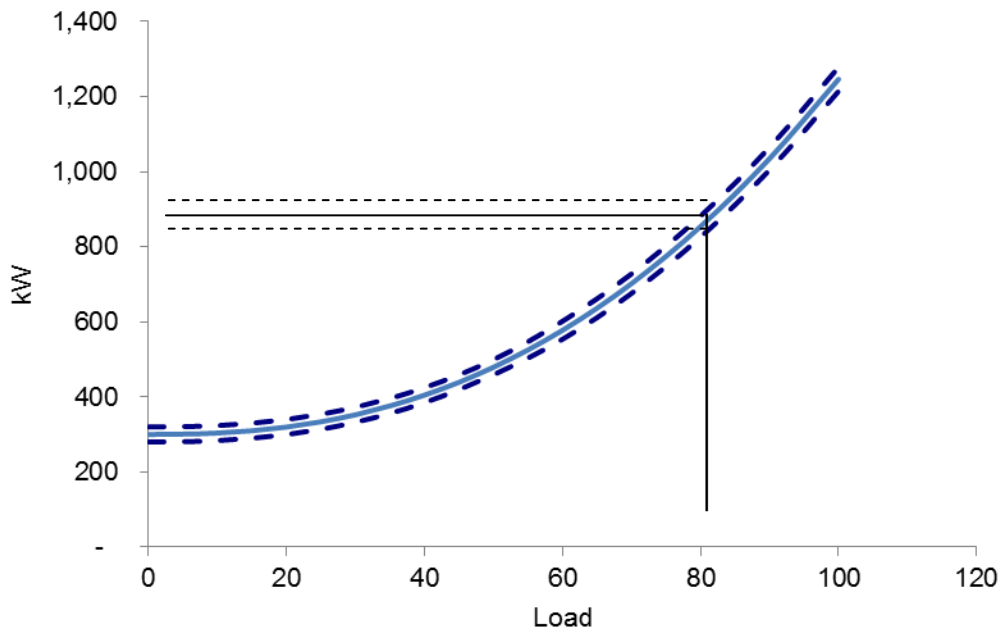

<sup>9</sup> *ASHRAE Guideline 2-2010: Engineering Analysis of Experimental Data.*

### 5.3. Timed Schedule

For timed schedules, the total operation hours for the year are constant, whether the load is constant or variable. For variable loads, the number of hours in each load bin is constant. If operating hours are monitored throughout the year, there is very little uncertainty in the result. However, rarely is it cost-effective to monitor hours for the entire year, unless such data is already available. For these cases, a representative period of operation is selected, operation hours are measured, and annual operation hours are determined by extrapolation. Usually an average daily or average weekly number of operation hours over a representative time period are determined for each load bin (whether constant or variable load) of the load frequency distribution. These averages have associated confidence intervals, as shown in Figure 5-2, for one load bin, and are assumed to be representative of the annual daily or weekly load bin operation hours. The uncertainty of the estimated annual operation hours of each load bin is assumed to be the same as that for the representative period. Please refer to the BPA *Sampling for M&V: Reference Guide* for more information on using samples.

**Figure 5-2: Representations of Uncertainty in Load Frequency Distributions**

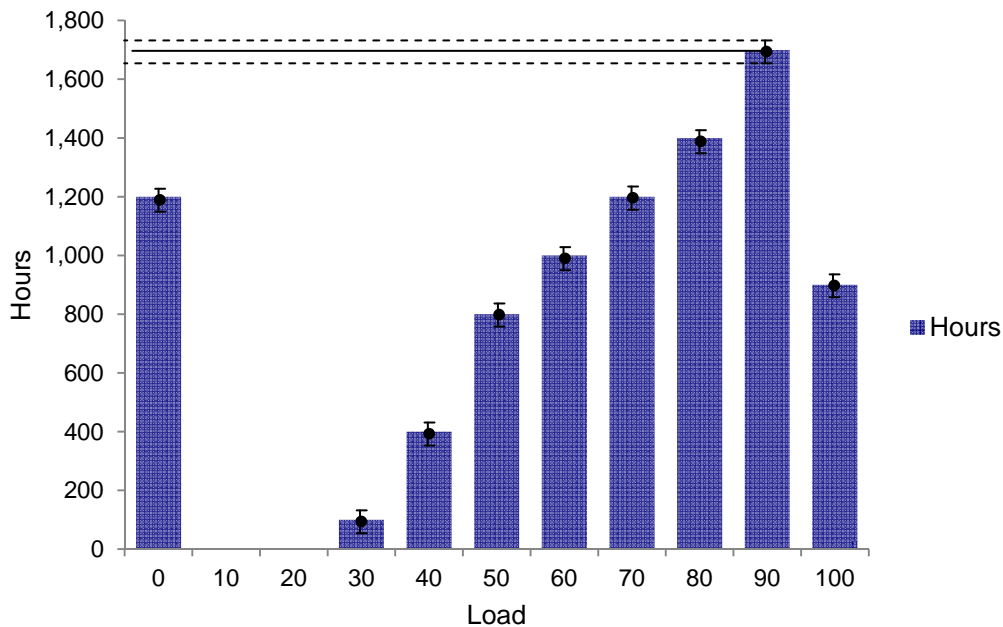

### 5.4. Variable Schedule

For many cases, the strategy outlined above may be used to determine the uncertainty in annual operation hours. For other cases, the hours-of-use may be dependent on an external parameter, such as when the hours-of-use increase or decrease depending on the season. In such cases, a regression relationship between hours-of-use and ambient temperature may be developed. The uncertainty in the predicted hours-of-use would then be developed in the same way as in the case of variable load above.



## 6. Minimum Reporting Requirements

### 6.1. Measurement and Verification Plan

#### 6.1.1. Essential Elements of the Measurement and Verification Plan

Proper savings verification requires planning and preparation. The IPMVP lists several requirements for a fully-adherent M&V plan.<sup>10</sup> The *End-Use Metering Protocol* describes methods for verifying savings in equipment and end uses. This protocol describes planning requirements, as well as specific measurement and analysis activities in the baseline and in the post-installation periods. Documenting in an M&V Plan how these requirements will be met is important so that others who subsequently become involved in the project can obtain a full understanding of the project's history and progress. The following are the essential items in documenting a savings verification plan.

- **Measurement Boundary:** Define the boundary around the equipment or end use within which the savings will be verified. This boundary can be around a specific piece of equipment, such as a pump and its motor, or a combination of equipment comprising a building subsystem, such as an air-handling system or chilled-water system.
- **Baseline Equipment and Conditions:** Document the end-use baseline systems, equipment configurations, and operational characteristics (operating practices or operation schedules that characterize load or hours-of-use). This includes equipment inventories, sizes, types, and condition. Describe any significant problems with the equipment.
- **Energy and Independent Variable Data:** Describe how equipment load is characterized and what additional parameters are required to characterize it. Describe its operating practices or operation schedules that characterize its hours-of-use. Include all energy data from spot measurements and short- or long-term monitoring from each source where data was collected. Define the baseline time period for the end use.
- **Reporting Period:** Describe the length of the reporting period and the activities that will be conducted, including data collection and sources.
- **Analysis Procedure:** Describe how the baseline and post-installation energy use or demand will be adjusted to a common set of conditions. Describe the procedures used to prepare the data. Describe the procedures used for analyzing the data and determining savings. Describe any extrapolations of energy use or savings beyond the reporting period. Describe how savings uncertainty (if required) will be estimated. Document all assumptions.

---

<sup>10</sup> Chapter 5, *IPMVP Volume I – 2010*.

- **Option A Requirements:** For each non-key parameter, specify the basis for the estimated values used. Describe their source or sources. Describe the impact of any significant variation in the values used and what otherwise would be measured on the calculated savings.
- **Savings Verification Reports:** Describe what results will be included in the savings reports. Describe what data and calculations will be provided. Describe when savings will be reported for the project. Indicate the reporting format to be used. See the section below regarding the *Savings Verification Report* for the minimum requirements.

### 6.1.2.M&V Plan Additional Elements

The IPMVP describes several other elements of a good M&V plan. These items are good practice in general, but not necessary for every project. Many of them are provided here for reference and consideration for inclusion in M&V Plans written under this protocol.

- **Energy Prices:** Document the relevant energy prices to be used to value the savings. This can be a blended electric rate or a schedule of rates based on time-of-use. Note that the latter will add significant complexity to the calculations.
- **Measurement Instrument Specifications:** Document the instruments used to obtain the data used in the calculations, including their rated accuracy and range. Identify the last instrument calibration date.
- **Budget:** Estimate the budget required for the savings verification activity. Estimate labor and material (e.g., meters and instruments, associated safety equipment, etc.) costs and provide an approximate schedule for when activities will occur.
- **Quality Assurance:** Describe any quality assurance activities that will be conducted as part of this M&V project. This may include how data is validated, how IPMVP Option A estimates are checked, identifying other parties who will review the work, and so on.

### 6.1.3.Documentation for BPA Database

The documentation should also include the following information to support review and inclusion of the project and measure in the BPA *Energy Efficiency Central* database (*EE Central*):

- Utility name
- Utility program
- Sector (commercial/industrial/residential)
- Existing building or new construction
- Site address (this will be used to establish the climate zone)
- Building type (examples: office, school, hospital)
- Building size, square feet

- ➔ Affected end uses (examples: HVAC, interior lights, exterior lights, receptacle plugs, DHW)
- ➔ Affected system (examples under HVAC: cooling plant, heating plant, HVAC fans, terminal units, controls)
- ➔ Affected equipment type (examples under cooling plant: chiller, packaged unit, cooling tower, pumps)
- ➔ Measure type (broad category)
- ➔ Measure name (specific category)

## 6.2. Savings Verification Report

### 6.2.1. General Verification Report Requirements Based on IPMVP

After the M&V calculations have been completed, the savings and actual M&V process used need to be documented.

Per the IPMVP, the *Savings Verification Report* should follow the savings verification report requirements described in the project's M&V Plan. Any deviations from the M&V Plan must be clearly described. If the M&V method followed the M&V Plan, then the information in the M&V Plan does not need to be repeated, but can just reference the Plan. However, deviations from the planned method, measurement boundary, baseline characteristics, etc. necessitate new descriptions.

*IPMVP Chapter 6, M&V Reporting*, generally requires the following:

- ➔ Report both energy and cost savings.
- ➔ Report the data relevant to the reporting period, including the measurement period and the associated energy data and independent variables. Any changes to the observed data must be described and justified.
- ➔ Describe any non-routine baseline adjustments, including the details of how the adjustments were calculated.
- ➔ Report the energy prices or rates used in the cost-savings calculations.

In addition, actual data for baseline and post-period energy use should both be reported.

### 6.2.2. Additional Savings Verification Report Requirements

#### **Load and Schedule Relationships**

In the basic procedure for the *Verification by Equipment or End-Use Metering Protocol*, one of the numbered items states, "Determine the relationships between load and hours-of-use terms in the energy savings equation and other parameters, such as temperature, air or water flow,

pressure, and so on.” This includes the relationships of daytypes and seasons to load and hours-of-use.

These relationships are important for all protocols, not just the *End-Use Metering Protocol*. In general, if the power or energy varies with respect to ambient temperature or another independent variable, then a relationship (e.g., regression) must be developed. Schedule variations require similar considerations.

The energy modeling protocol is obviously built on these relationships, and energy indexing uses the ratio between energy and some independent driving variable – another relationship. Similarly, spreadsheet-based engineering calculations should use relationships (also described as correlations) to describe the load.

The savings verification report should clearly define loads and schedules, and their relationship to other variables:

- ➔ **For a constant load**, the load value and units should be provided, as well as how the load value was obtained. If any proxies are used to define the load, the proxies should be justified and their development described.
- ➔ **For variable load**, the load frequency distribution should be provided, along with a description of how it was obtained. For loads that can be any value, they should generally be grouped into 5 to 10 bins, but this is dependent upon how much the load varies. For example, if the load varies from 0% to 100%, 10 bins might be appropriate, but if the load only varies from 80% to 100%, then 2 to 4 bins might be appropriate.
- ➔ **For a timed schedule**, report the source for the schedule and the total annual hours.
- ➔ **For a variable schedule**, report the source for the estimate of the hours during the measurement period and the total annual hours.

Variable load information, energy models, and load correlations for engineering calculations are all similar and should be shown graphically in an x-y (scatter chart), as well as an equation or table. Load frequency distributions should be shown in both a bar chart and a table.

## Savings Verification Report Information

The report should include the following information. It may be organized in this order with a separate section for each of these items, or in another order or organization that makes sense for a particular program or project. However it is reported, all of this information should be included in most cases:

1. The data for the baseline period, including the time period, monitoring intervals, and data points should be described.
2. The load and schedule for the baseline period, and any relationships associated with variable loads or schedules, should be clearly defined.
3. The impact of the ECM on the load or hours-of-use in the reporting period should be described.

4. The data for the reporting period, including the time period, monitoring intervals, and data points should be described.
5. The load and schedule, and any relationships associated with variable loads or schedules, should be clearly defined for the reporting period.
6. The equations used to estimate baseline consumption, reporting period consumption, and savings should be listed and explained.
7. Report consumption (and where relevant, demand), as well as savings, since this facilitates review and reasonableness checks.
8. As required by IPMVP, report the energy prices or rates used in the cost savings calculations.
9. Also, as required by IPMVP, report both energy and cost savings.
10. Provide verification of potential to generate savings.

## Post Installation Verification of Potential to Generate Savings

*IPMVP Section 4.3* requires that, “After the ECM is installed, inspect the installed equipment and revised operating procedures to ensure that they conform to the design intent of the ECM.” Therefore, an IPMVP-adherent process requires evidence that the efficiency measures have the potential to generate savings. BPA may require short-term monitoring, spot measurements, production data, or other forms of verification to confirm potential.

Verification includes notation of any changes to the project subsequent to the M&V plan. If the project changed, the energy and demand savings should be recalculated based on as-installed conditions. Data and analysis from metering performed before or after installation should be included with the calculations.

In general, verification of potential to generate savings can take either of two forms:

- ➔ Installation verification
- ➔ Operational verification

### ***Installation Verification***

*Installation verification* is the less rigorous of the two verification methods. It demonstrates the measures were installed as planned. This demonstration may vary by measure. Project developers are required to describe the evidence and documentation they plan to provide to demonstrate that the measures were installed, and this evidence and documentation belongs in the savings verification report.

Examples of installation verification include:

- ➔ Photographs of new equipment
- ➔ Photographs of new control set-points

- ➔ Screen captures from EMCS
- ➔ Invoices from service contractors (invoices should not be the sole form of evidence, but may supplement other verification documentation).

### ***Operational Verification***

*Operational verification* demonstrates that in the post-installation period, the system is operating (or not operating) as modeled in the calculations. It is based on visualization of *operational* data (as opposed to *energy* data) collected during one or more site visits after the measures have been installed.

Operational verification is in addition to installation verification and documentation should include the same types of evidence as for installation verification. In addition, the data logging, control system trending, or functional tests used to establish baseline shall be repeated to demonstrate that operations have been improved. Documentation of the commissioning of the new systems or equipment can be used for operational verification.

If the collected post-installation data, test results, and/or commissioning indicate less than predicted performance, or that the measures were not installed as assumed in the savings calculations (for example, due to incorrect or partial installation, or other circumstance), either:

- ➔ Take action to help the customer fully install the measure properly and then re-verify it using these procedures; or
- ➔ Use the same calculation methodology with the post-installation data to calculate a revised measure savings estimate.

### ***Choice of Verification Method***

Common, well-known measures, measures with low expected savings, and measures whose savings estimates have considerable certainty, may need only installation verification. Measures with large savings and measures with less certain savings (whose savings can vary greatly dependent upon application) typically require operational verification.

Thus, there is no hard-and-fast rule for this choice. The analyst should recommend a verification method and the evidence expected to be presented for verification when submitting calculations or simulations. The final choice of verification method and evidence will be made by the reviewer.

## 7. Examples

The following are representative examples of how the *End-Use Metering Protocol* may be implemented for some common project types.

### 7.1. Example 1: Simple Pump Motor Replacement (Option B: ECM Reduces Load)

#### 7.1.1. Overview

Condenser water from a cooling tower in an automobile factory cools the painting process equipment and operates over two 8-hour shifts per day for 5 days per week. It does not operate on holidays. The tower has a 5-hp condenser water pump operating at constant load over these hours. Although it has several years of useful life remaining, the pump motor is eight years old and has a lower rated motor efficiency than newer models available. This motor will be replaced with a more efficient model. No changes to its operation are planned.

#### 7.1.2. M&V Approach

The end-use metering protocol will be used to calculate and verify the savings from this pump motor replacement project.

#### M&V Option

The *Option B: All Parameter Measurement M&V Option* will be used. Note, this method may not fully adhere to IPMVP requirements.

#### Measurement Boundary

The measurement boundary is drawn around the pump as shown in Figure 7-1. Since the water flow will not be changed, the only impact of this measure on energy use will be on the electric energy use. Electric energy use of the pump motor is the only savings to be verified during this M&V analysis (no gas savings, etc.).

#### Baseline Period

This pump and motor operate at constant load for a known amount of time. To verify constant load operation, a handheld wattmeter is used to read the power demand of the pump. Several one-minute interval readings are made with the wattmeter while the instrument is attached to the pump's motor control center circuits.

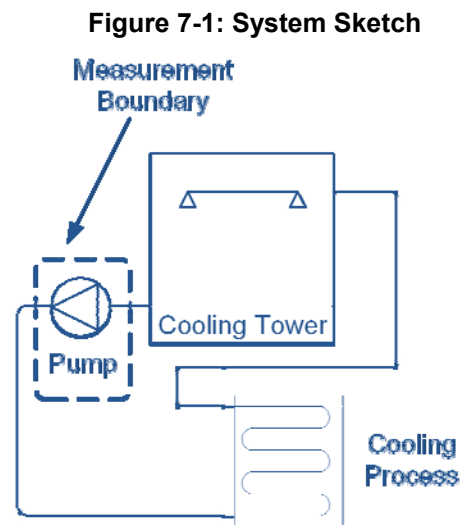

## Post-Installation Period

After the motor has been replaced, both the new wattage and operation schedule are measured. A power logger is placed on the motor’s power circuits in the motor control center and set to record its power at 15-minute intervals for two weeks, spanning two weekends of non-operation. Both the time and power readings are uploaded to a spreadsheet. Figure 7-2 shows a portion of the spreadsheet with the measured baseline and post-installation data. A time series chart in Figure 7-3 shows a snapshot of operation over one of the monitored weekends, confirming 16 hours per day of weekday operation, and no operation during the weekend.

**Figure 7-2: Energy Data**

Baseline		Post-Installation			
Reading no.	kW	Date & Time	kW		
1	5.97	7/16/09 10:45	5.67	Weeks per year	52
2	6.40	7/16/09 11:00	5.51	Holidays per year	12
3	6.59	7/16/09 11:15	5.57	Shutdown days per year	2
4	6.31	7/16/09 11:30	5.56	Weekdays per year	247
5	6.82	7/16/09 11:45	5.81	Weekend days per year	104
6	5.84	7/16/09 12:00	5.55	Operating days per year (check)	365
7	6.18	7/16/09 12:15	5.71	Operating hours per day	16
8	5.92	7/16/09 12:30	5.91	Total annual operating hours	5840
9	5.88	7/16/09 12:45	5.72		
		7/16/09 13:00	5.71		
Average	6.21	7/16/09 13:15	6.06	Average kW when operating	5.78
Standard Deviation	0.34	7/16/09 13:30	5.93	Standard Deviation	0.15
CV	0.06	7/16/09 13:45	6.03	CV	0.03

**Figure 7-3: Chart Representation**

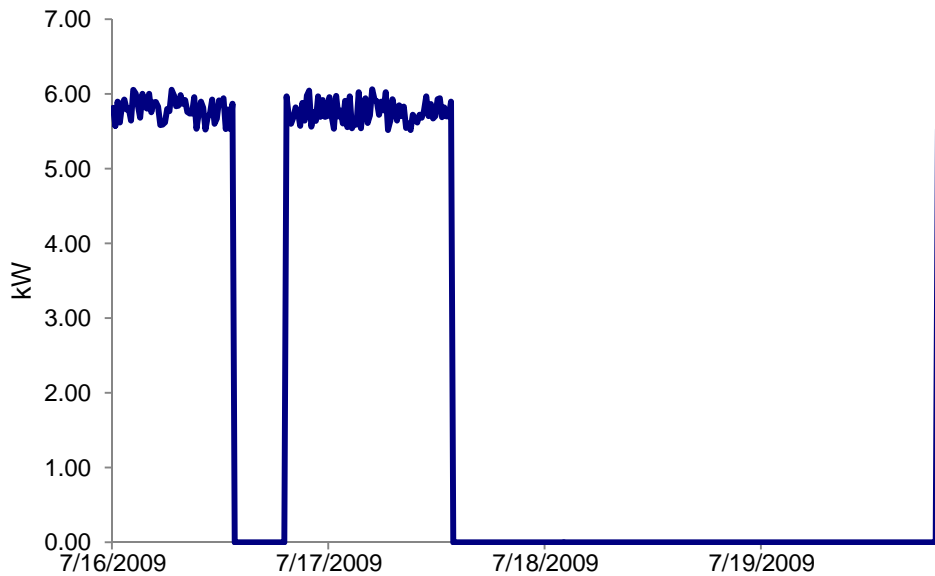

### 7.1.3. Algorithm

The baseline category is CLTS. Both load and operating schedule are constant. The number of operating hours each year is constant. The pump motor power will be measured in the baseline period.

Replacing the pump motor with a more efficient motor only reduces the motor power. The operating schedule does not change. The post-installation category is also CLTS. The pump motor kW and operating schedule were measured over a two-week period. Annual energy use is calculated by **Equation 1**, from Table 3-2:

■ **Equation 1:**  $kWh_{saved} = (kW_{base} - kW_{post})HRS_{post}$

### 7.1.4. Annual Savings

- ➔ The total operating hours are shown in the spreadsheet: 5,840 hours
- ➔ The energy savings are calculated to be  $(6.21 - 5.78) * 5,840 = 2,511$  kWh.

## 7.2. Example 2: Automobile Factory Paint Shop Exhaust Fans (Option A: ECM Reduces Schedule)

### 7.2.1. Overview

Exhaust fans in the paint shop at an automobile factory operated continuously throughout two 8-hour work shifts (6:00 am to midnight) during each work week. There were a total of 4 days of maintenance downtime in the previous year. There were four paint booths within the shop, each with 60-hp constant speed fans. The factory's engineering staff implemented controls in each paint shop to monitor air quality, and shut the fans off when the paint shop was not used and air quality was at acceptable levels. This resulted in the exhaust fans being operated only when needed as cars were cycled through the paint shop and significantly reduced the number of operation hours per year.

### 7.2.2. M&V Approach

The end-use metering protocol was used to calculate and verify the savings from this paint shop controls project.

### M&V Option

The *Option A: Key Parameter Measurement M&V Option* was used. The key parameter was the number of operation hours of the exhaust fans. Exhaust fan power will be estimated based on motor nameplate data and a spot measurement on each fan.

### Measurement Boundary

A measurement boundary was drawn around each exhaust fan, as shown in **Figure 7-4**. Exhaust fan motors were operated at constant speed during each shift of factory operation. The exhaust fan motors will not be affected by the planned changes. The only effect of the ECM was to reduce the hours of operation.

### Baseline Period

The baseline equipment was operated under a constant load timed schedule system (CLTS). The motor and fan were operated at a constant load for a known amount of time. The nameplate horsepower rating from each fan motor was collected; the brake horsepower was calculated and compared against a spot measurement of each fan’s power use when operating. This verified the engineering assumption of each fan’s power draw. The fan operation schedule was verified using a motor status logger on each of the four fans; logging was conducted over a 2-week period to verify that the fans operated continuously over both work shifts each working day. Results of the baseline motor status logging are shown in **Figure 7-5**.

**Figure 7-4: System Sketch**

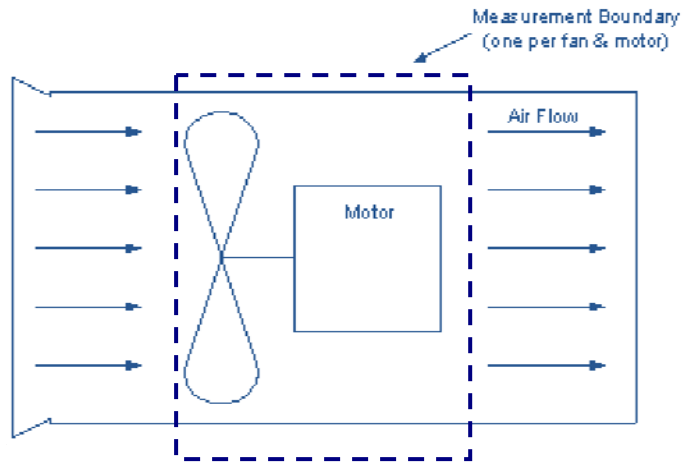

**Figure 7-5: Baseline Operation – Fan EXH 23**

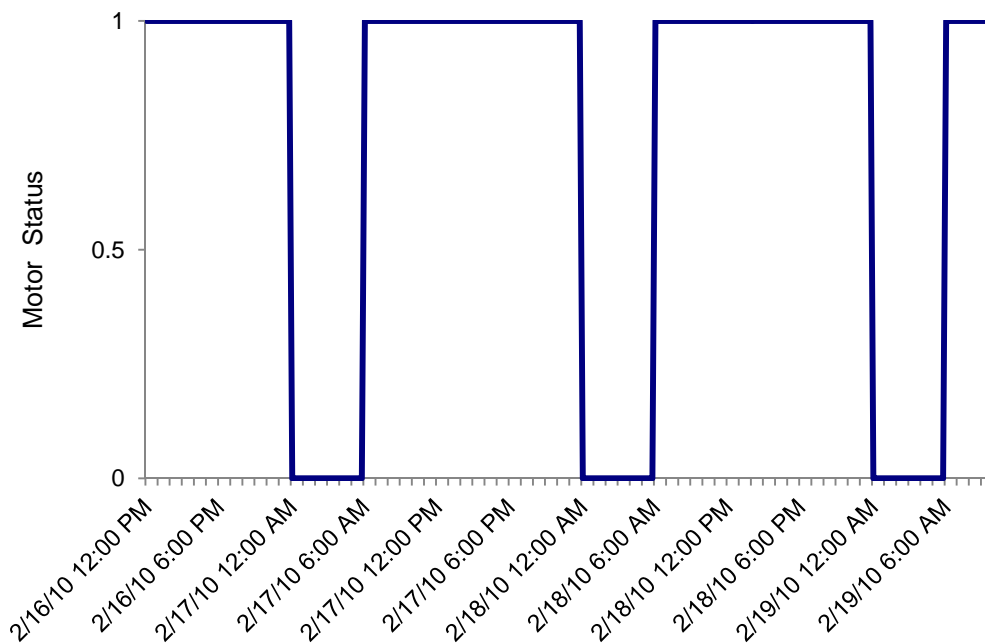

## Post-Installation Period

After the controls are installed, the equipment will still operate as a constant load; however, the operation schedule will change to a variable schedule system (CLVS) while the exhaust fans cycle on and off as the cars cycle through the paint shop.

Each fan motor’s power use when operating will be verified that it is unchanged, using a spot measurement of fan motor power. The exhaust fan schedule will be monitored by installing motor status loggers on each fan motor for one month duration. In addition, the paint shop logs of cars entering and leaving the shop during the monitoring period will be obtained.

Results of the monitoring and paint shop log review are shown in Figure 7-6.

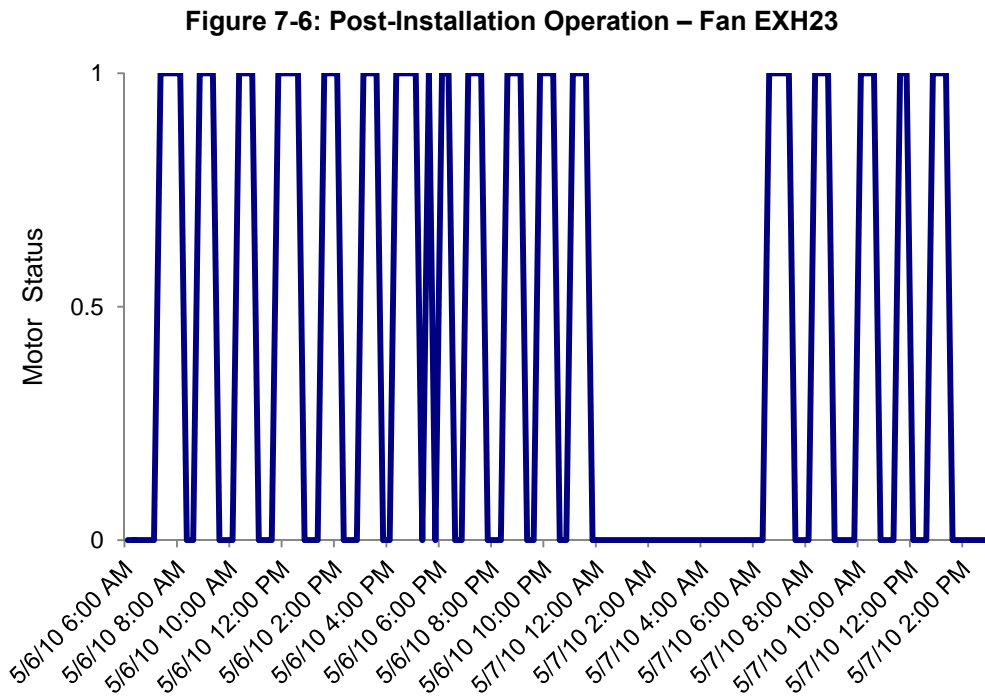

### 7.2.3. Algorithm

The baseline category is CLTS. The controls upgrade only affects hours of operation – enabling and operating the exhaust fans only as cars are cycled through the paint shop. The post-installation category is CLVS. The 60-hp fan motors were measured with a one-time spot measurement in the baseline period, while the fan operation hours were measured over a two-week period using motor status loggers on each exhaust fan. It was found that in the post-installation period, the fans operated 0.83 hours per car. The annual post-installation operation hours were found by consulting the paint shop log books and counting the number of cars painted per year. Annual energy use is calculated from Equation 2, from Table 3-2:

■ **Equation 2:** 
$$kWh_{saved} = kW_{base} \cdot HRS_{base} - kW_{base} \sum_i HRS_{post,i}$$

### 7.2.4. Annual Savings

The baseline motor power data and annual savings calculation are shown in Figure 7-7. Annual operation hours were reduced from 2,916 to 1,822.5 hours per year. This resulted in an annual electric energy savings of 167,623 kWh and cost savings of over \$18,000 per year.

**Figure 7-7: Savings Calculations**

Spot Measurements		Baseline Data		Post-Installation	
<b>Fan Motor EXH23</b>		Total on-time (hrs): 2,916		Average on-time per car: 0.83	
Motor Nameplate HP:	60	Motor Power (kW): 39.4		# cars per year: 2,187	
Power measurement*	39.4	Annual energy use (kWh): 114,890		Total annual on-time: 1,822.5	
				Motor Power (kW): 39.4	
				Annual energy use (kWh): 71,807	
<b>Fan Motor EXH24</b>				Annual savings EXH23 (kWh): 43,084	
Motor Nameplate HP:	60			Annual savings EXH24 (kWh): 42,100	
Power measurement*	38.5			Annual savings EXH25 (kWh): 40,131	
				Annual savings EXH26 (kWh): 42,318	
				Total Annual Savings (kWh): 167,634	
				Cost Savings: \$ 18,440	
*Powersight meter					

## 7.3. Example 3: Supply Fan IGV to VSD Conversion (Improved Fan Efficiency)

### 7.3.1. Overview

Supply air to an office building is provided by a variable volume reheat system with mechanical cooling that operates Monday to Friday from 6:00 am to 10:00 pm. The volume of air is varied by dampers in the VAV boxes. As the dampers close down, the inlet guide vanes (IGV) also close down to maintain duct static pressure, reducing the flow of air through the fan, and the fan motor uses less energy. The supply fan uses a 30-hp motor and flows 35,100 CFM with the IGV wide open. The IGV will be replaced by a variable speed drive (VSD) which will reduce the fan motor’s consumption at a given flow.

### 7.3.2. M&V Approach

The end-use metering protocol will be used to calculate and verify the savings from this IGV to VSD conversion project.

## M&V Option

The *Option B: All Parameter Measurement M&V Option* will be used.

## Measurement Boundary

The measurement boundary is drawn around the fan and motor as shown in Figure 7-8. Since the air flow will not be changed, the only impact of this measure will be on the electric energy use. Electric energy use of the fan motor is the only savings to be verified during this M&V analysis (no gas savings, etc.).

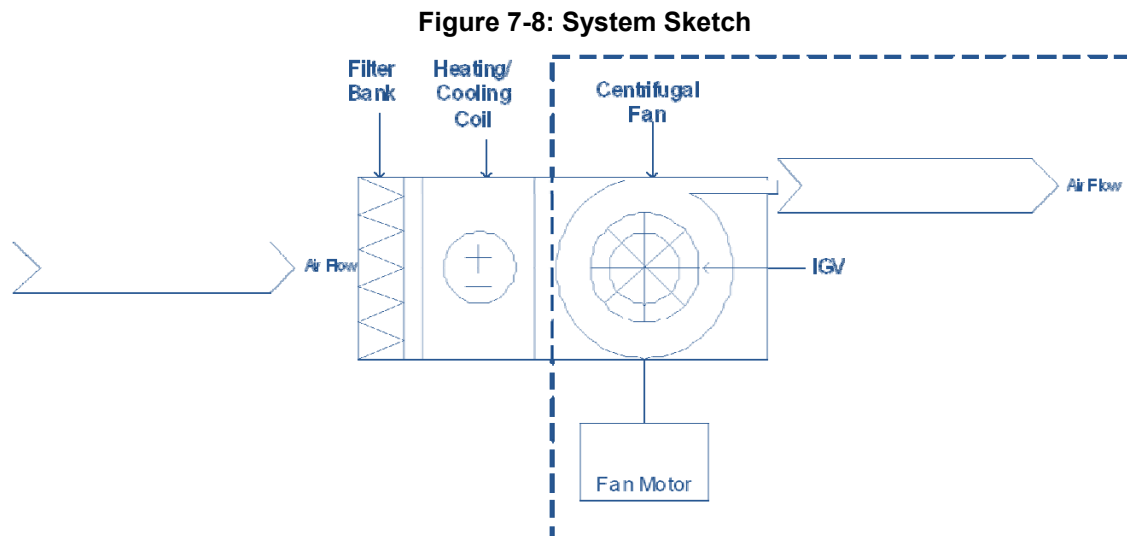

## Baseline Period

The fan operates to maintain its required flow to maintain space conditions, so the air-flow rate will be used as the load variable. The fan and motor operate at variable flow, spending unknown amounts of time at each flow rate, but with a known total operation hours for the year. Total known operation hours are based on the daily HVAC operation schedule and the number of operating days per year. This system is a variable load, timed schedule (VLTS) system.

The effect of the VFD will be to lower the kW required to produce the required air flow. In the baseline period, only the power/flow-rate relationship will be determined.

To verify variable load operation in this instance, a handheld flow meter is used to read the flow, and the IGV position at each flow is recorded, as the flow is modulated by the zone terminal box dampers. Figure 7-9 shows the relationship between flow and power and Figure 7-10 shows a portion of the spreadsheet with the measured baseline data.

**Figure 7-9: Relationship between Power and Flow**

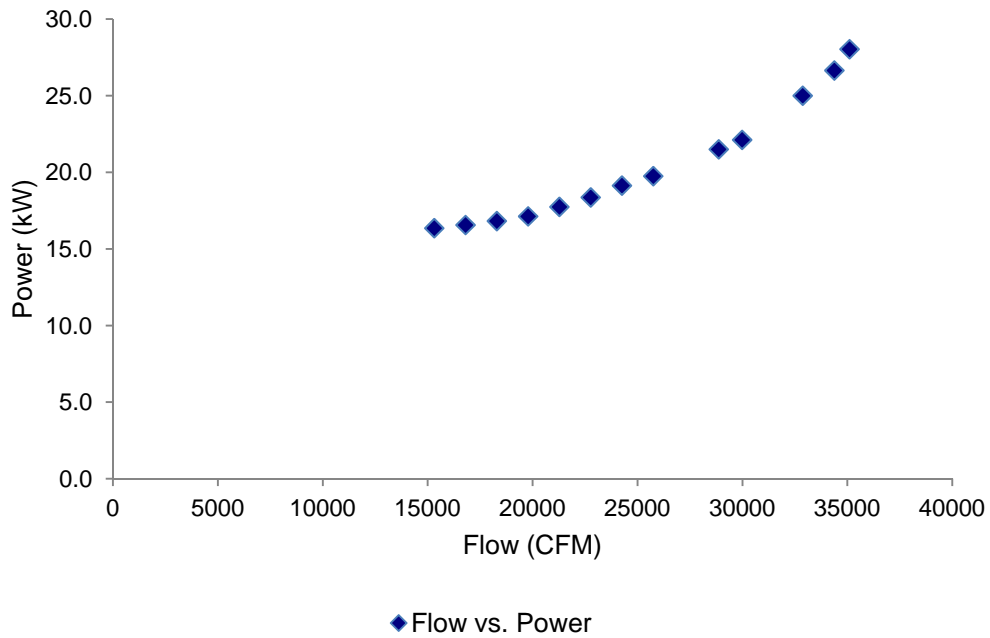

**Figure 7-10: Baseline Energy Data**

Baseline Reading No.	IGV Position	Flow	kW
1	0.40	15309	16.4
2	0.45	16800	16.6
3	0.50	18291	16.8
4	0.55	19782	17.1
5	0.60	21273	17.7
6	0.65	22764	18.4
7	0.70	24255	19.1
8	0.75	25746	19.8
9	0.80	28866	21.5
10	0.85	29982	22.1
11	0.90	32867	25.0
12	0.95	34376	26.7
13	1.00	35100	28.0
		Average kW	20.4
		Standard Deviation	4.0
		CV	0.2

## Post-Installation Period

After the IGV have been replaced with a VFD, a new power-flow curve must be determined. The load frequency distribution of the number of hours at each flow bin must also be determined. The system has not changed categories; it is still a VLTS system.

After the IGV has been replaced, the new wattage, flow, and VSD speed are spot measured over a number of operating points. A new power-flow curve is developed, as shown in Figure 7-11.

**Figure 7-11: Post-Installation Power versus Flow Curve**

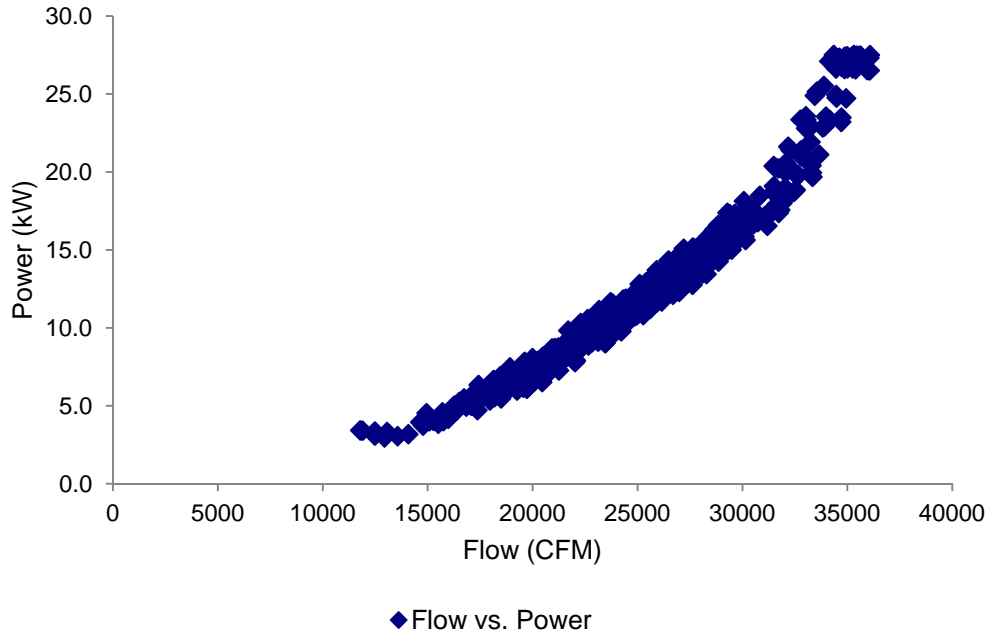

Ambient temperature and VFD speed are trended in the building’s control system. The trended VFD speed is converted to air flow using a relationship between VFD speed and air-flow rate determined from the collected test data – which follows the one-to-one relationship of the affinity laws. A regression relationship between the flow and ambient temperature is developed. A load frequency distribution is developed from a typical mean year (TMY) weather file for the local climate zone, and the regression relationship is used to convert ambient temperature to air-flow rate. The data are shown in Figure 7-12, the resulting load frequency distribution is shown in Figure 7-13.

**Figure 7-12: Post-Installation Energy Data**

Post-Install				Trends									
Reading No.	VSD Speed	Flow	kW	Date/Time	OAT	VSD Speed	Flow	kW					
1	0.40	14040	3.4	4/1/2009 16:00	16	50	0.64	22221	9.9			Weeks Per Year	52
2	0.45	15698	4.2	4/1/2009 17:00	17	50	0.64	21957	9.1			Hours Per Day	16
3	0.50	17455	5.2	4/1/2009 18:00	18	50	0.64	22807	9.2			Weekdays Per Year	261
4	0.55	19503	6.7	4/1/2009 19:00	19	50	0.64	21876	9.5			Total Annual Operating Hours	4,176
5	0.60	21106	8.2	4/1/2009 20:00	20	49	0.62	21918	8.8				
6	0.65	22815	9.8	4/1/2009 21:00	21	49	0.62	21243	8.7			Average kW when operating	12.9
7	0.70	24570	11.3	4/2/2009 6:00	6	64	0.92	31564	20.3			Standard Deviation	5.735141
8	0.75	26431	12.9	4/2/2009 7:00	7	61	0.86	31184	16.5			CV	0.444079
9	0.80	27985	14.3	4/2/2009 8:00	8	59	0.82	29177	15.9				
10	0.85	29566	16.1	4/2/2009 9:00	9	58	0.80	28547	14.4			Annual Electric Consumption	133,518
11	0.90	31623	18.8	4/2/2009 10:00	10	56	0.76	26499	13.0			(based on extrapolation)	
12	0.95	33224	21.5	4/2/2009 11:00	11	54	0.72	25581	11.8				
13	1.00	35100	27.0	4/2/2009 12:00	12	53	0.70	24490	11.5				
				4/2/2009 13:00	13	49	0.62	22621	9.3				
				4/2/2009 14:00	14	50	0.64	22168	9.8				
				4/2/2009 15:00	15	51	0.66	23398	10.4				
				4/2/2009 16:00	16	50	0.64	21806	9.1				
				4/2/2009 17:00	17	47	0.58	21027	8.0				
				4/2/2009 18:00	18	42	0.48	16265	5.0				
				4/2/2009 19:00	19	37	0.38	12481	3.4				
				4/2/2009 20:00	20	37	0.38	12481	3.1				
	Average kW	12.3		4/2/2009 21:00	21	37	0.38	12939	3.0				
	Standard Deviation	7.1		4/3/2009 6:00	6	71	1.00	34574	27.2				
	CV	0.6		4/3/2009 7:00	7	73	1.00	35231	27.4				

**Figure 7-13: Load Distribution Chart**

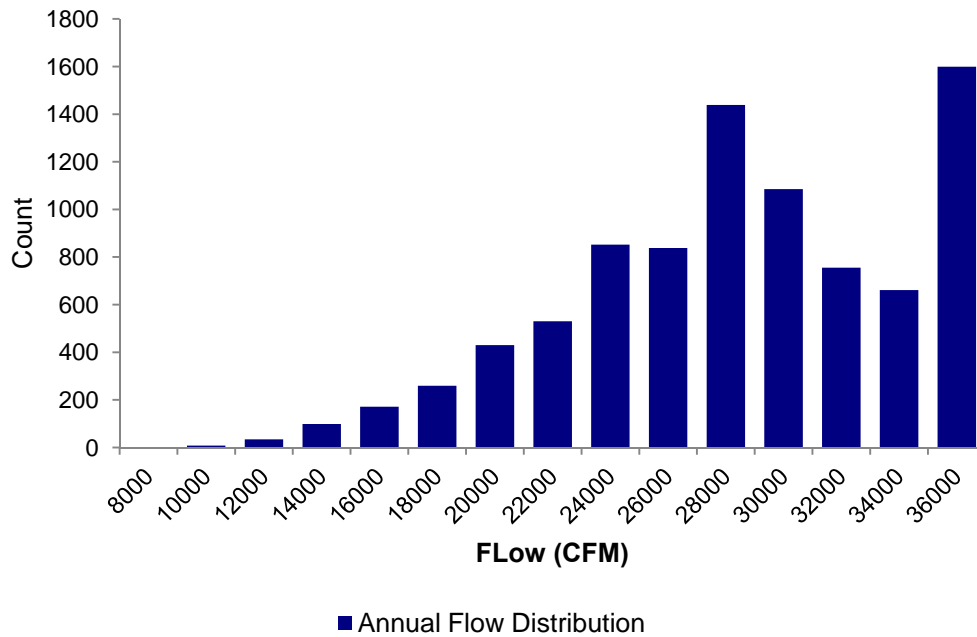

### 7.3.3. Algorithm

Both the baseline and post-installation load characteristics were measured. The hours of operation at various loads were measured for a short time period and annual hours were determined through a relationship with ambient temperature.

Replacing the IGVs with a VSD improves the efficiency of the fan, which only reduces the motor power required. The hours of operation at each flow are determined from the post-installation period, so that baseline and post-installation energy use are determined from the same set of conditions. Annual energy use is calculated by Equation 3, from Table 3-3 using the histogram of flow from the post-installation case:

■ **Equation 3:**  $kWh_{saved} = \sum_i [(kW_{base,i} - kW_{post,i}) \cdot HRS_{post,i}]$

### 7.3.4. Annual Savings

The calculations of energy savings are shown in Figure 7-14.

**Figure 7-14: Savings Calculations**

Flow		Baseline		Post-Installation		Savings
<i>Bin</i>	<i>Frequency</i>	Energy		Energy		
		<i>kW</i>	<i>kWh</i>	<i>kW</i>	<i>kWh</i>	<i>kWh</i>
8000	0	14.4	-	0.8	-	-
10000	8	15.1	120	1.3	10	110
12000	34	15.6	530	2.0	66	463
14000	99	16.0	1,583	2.7	272	1,312
16000	171	16.3	2,795	3.7	630	2,165
18000	259	16.7	4,321	4.8	1,237	3,083
20000	430	17.1	7,332	6.0	2,591	4,740
22000	530	17.5	9,274	7.4	3,941	5,334
24000	852	18.1	15,400	9.0	7,674	7,726
26000	838	18.8	15,777	10.7	9,004	6,773
28000	1439	19.8	28,496	12.7	18,205	10,291
30000	1085	21.1	22,840	14.7	15,980	6,860
32000	755	22.6	17,077	17.0	12,820	4,257
34000	661	24.6	16,231	19.4	12,828	3,403
36000	1599	26.9	43,024	22.0	35,198	7,826
			184,799		120,457	64,342

## 7.4. Example 4: Constant Volume Blower to Variable Volume

### 7.4.1. Overview

A waste water treatment plant has one blower system serving four aeration basins. Each aeration basin has five zones. The basins' treatment process follows the aerated grit removal and primary sedimentation treatment processes. In the basins, the primary effluent undergoes aerobic biological treatment from the blower system, which consists of four 125-hp multi-stage centrifugal blowers. Typical blower operation requires two blowers to maintain DO levels, meaning that the other two are cycled into operation every other month. The blowers move air into a common manifold that transports the air to the aeration basins to maintain an average dissolved oxygen (DO) level of 2.0 mg/l across the 5<sup>th</sup> zone of each basin. Currently there are no controls or control valves for balancing the air flow and the ponds/zones have independently fluctuating DO levels. Consequently, the plant maintains an average DO value, which is only slightly representative of the DO values in each pond. By installing motorized valves and additional DO sensors, the blower system can be better controlled to maintain the set point evenly across all five zones in each of the four ponds while using less power.

### 7.4.2. M&V Approach

The end-use metering protocol will be used to calculate and verify the savings from this constant volume to variable volume conversion project.

#### **M&V Option**

The *Option B: All Parameter Measurement M&V Option* will be used.

#### **Measurement Boundary**

The measurement boundary is drawn around the blowers, their motors, and the aeration ponds as shown in Figure 7-15. By reducing the blower system's output as appropriate for maintaining DO levels, this measure saved electric energy. Electric energy use of the blower motors was the only savings to be verified during this M&V analysis (no gas savings, etc.).

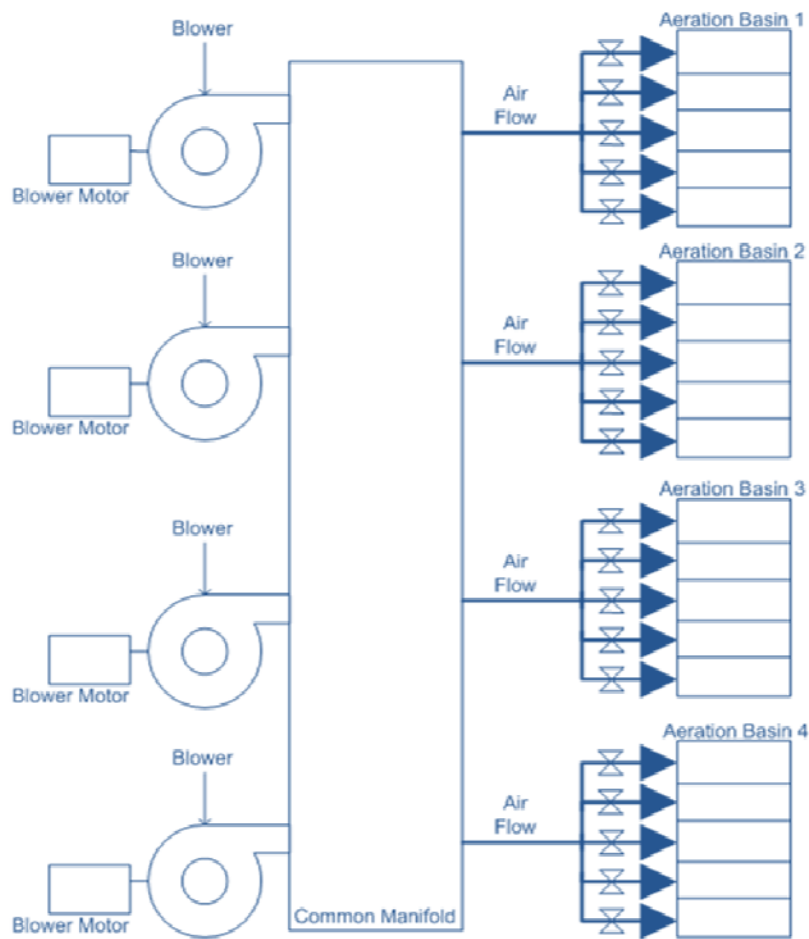
**Figure 7-15: System Sketch (not to scale)**

## Baseline Period

The blowers were operated to provide the air required to maintain the average DO level across the 5<sup>th</sup> zone of each basin, so the air flow rate was used as the load variable. The blowers and motors operated at variable flow, spending unknown amounts of time at each flow rate, but with a known total operation hours for the year. Total known operation hours were 8,760, because the plant had to run continuously to maintain the system balance. This system is a variable load, timed schedule (VLTS) system.

The effect of the additional valves and DO sensors was to lower the kW required by reducing the required air flow. In the baseline period, the power/flow-rate relationship was determined, as was the load frequency distribution for the number of hours at each flow rate. The procedure for determining the load curve (power versus flow) and load frequency distribution in the baseline period is outlined below:

- ➔ Spot measure power, pressure, and blower speed. For each blower, this will identify a point on the blower's performance curve.

- ➔ Trend blower speeds and ambient temperatures in the plant’s control system. The trend period was two months.
- ➔ Calculate the power for each trended point based on the affinity law and trended speeds.
- ➔ Calculate the air flows through the blowers for the trend period based on the manufacturer’s blower curve and the spot measurements. From this data, a correlation between blower speed and ambient temperature was developed. Since blower speed is proportional to air flow and the rate of dissolved oxygen consumed by the pond’s bacteria, and thus required air flow, varies with ambient temperature, a relationship between flow and temperature, and annual weather data, will be used to develop the load frequency distribution.

Figure 7-16 shows a portion of the spreadsheet with the measured baseline data.

**Figure 7-16: Baseline Energy Data**

Baseline Reading No.	VSD Speed	pressure (psig)	kW	Deg F	Trends Date/Time	OAT	VSD Speed	Flow	kW			
Blower 1	0.85	5.25	68.6	70	2/1/2009 0:00	53	0.94	2561	212.3			
Blower 2	0.85	5.25	70.2	70	2/1/2009 1:00	48	0.97	2669	238.1			
			138.8		2/1/2009 2:00	44	0.99	2637	220.5			
					2/1/2009 3:00	40	1.00	2695	220.2	Total Annual Operating Hours	8,760	
					2/1/2009 4:00	39	1.00	2565	222.6			
					2/1/2009 5:00	38	1.00	2574	201.4	Average kW when operating	202.2	
					2/1/2009 6:00	38	1.00	2607	228.0	Standard Deviation	17.86	
					2/1/2009 7:00	37	1.00	2667	197.0	CV	0.09	
					2/1/2009 8:00	41	1.00	2574	200.4			
					2/1/2009 9:00	52	0.95	2576	192.5			
					2/1/2009 10:00	54	0.93	2512	190.3			
					2/1/2009 11:00	60	0.90	2458	187.8			
					2/1/2009 12:00	63	0.89	2354	186.4			
					2/1/2009 13:00	64	0.88	2299	193.9			
					2/1/2009 14:00	64	0.88	2336	188.9			
					2/1/2009 15:00	64	0.88	2423	184.0			
					2/1/2009 16:00	63	0.89	2377	173.3			
					2/1/2009 17:00	60	0.90	2492	205.6			
					2/1/2009 18:00	57	0.92	2404	183.5			
					2/1/2009 19:00	52	0.95	2455	218.7			
					2/1/2009 20:00	47	0.97	2551	221.5			
	Average kW		69.4		2/1/2009 21:00	45	0.99	2676	201.7			
	Standard Deviation		1.141		2/1/2009 22:00	45	0.99	2586	236.3			
		CV	0.016		2/1/2009 23:00	44	0.99	2602	192.6			

### Post-Installation Period

After the motorized valves, additional DO sensors, and controls were installed, the power-flow relationship remained the same; however, a new load frequency distribution of hours at a given flow bin was determined. In the baseline, due to a lack of DO feedback, the blowers over-ventilated the ponds. In the post-installation period, the flow rate will be lowered while still maintaining the required DO level.

The system pressure set point has remained constant throughout this period, so with a new set of power measurements, the flow can be determined from the blower curves, as it was in the baseline. The load frequency distribution was determined in the same way as it was in the baseline. The system has not changed categories; it is still a VLTS system. A portion of the data gathered for the post-installation period can be seen in Figure 7-17 below.

**Figure 7-17: Post-Installation Energy Data**

Post-Install				Trends									
Reading No.	VSD Speed	pressure (PSI)	kW	Date/Time	OAT	VSD Speed	Flow	kW					
Blower 1	0.53	5.25	25.7	8/20/2009 0:00	55	0.72	1944	171.9					
Blower 2	0.53	5.25	26.3	8/20/2009 1:00	55	0.72	1875	144.2					
			52.1	8/20/2009 2:00	56	0.71	1957	149.0					
				8/20/2009 3:00	56	0.71	1849	129.1		Total Annual Operating Hours		8,760	
				8/20/2009 4:00	55	0.72	2012	179.4					
				8/20/2009 5:00	55	0.72	1938	145.4		Average kW when operating		131.5	
				8/20/2009 6:00	55	0.72	1833	172.8		Standard Deviation		28.23159	
				8/20/2009 7:00	55	0.72	1822	152.9		CV		0.214615	
				8/20/2009 8:00	57	0.69	1900	158.2					
				8/20/2009 9:00	64	0.59	1607	139.4					
				8/20/2009 10:00	71	0.51	1272	82.0					
				8/20/2009 11:00	71	0.51	1319	108.8					
				8/20/2009 12:00	75	0.46	1153	93.2					
				8/20/2009 13:00	74	0.47	1264	107.3					
				8/20/2009 14:00	74	0.47	1160	110.8					
				8/20/2009 15:00	73	0.49	1285	96.0					
				8/20/2009 16:00	69	0.53	1464	129.6					
				8/20/2009 17:00	66	0.57	1504	107.9					
				8/20/2009 18:00	62	0.62	1674	155.8					
				8/20/2009 19:00	57	0.69	1759	131.7					
				8/20/2009 20:00	56	0.71	1819	129.7					
		Average kW	34.7	8/20/2009 21:00	56	0.71	1811	170.0					
		Standard Deviation	15.0296	8/20/2009 22:00	56	0.71	1919	173.9					
		CV	0.4331	8/20/2009 23:00	56	0.71	1873	148.1					

The baseline and post-installation power/load relationships, and load frequency distributions are shown in Figure 7-18 and Figure 7-19 below.

**Figure 7-18: Post-Installation Power versus Flow Curve**

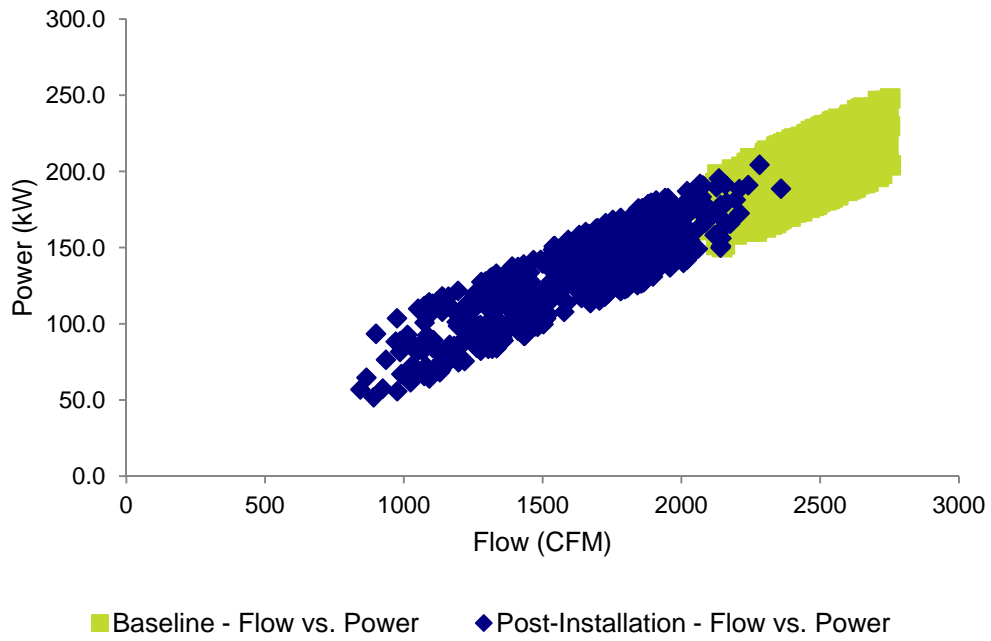

**Figure 7-19: Load Distribution Chart**

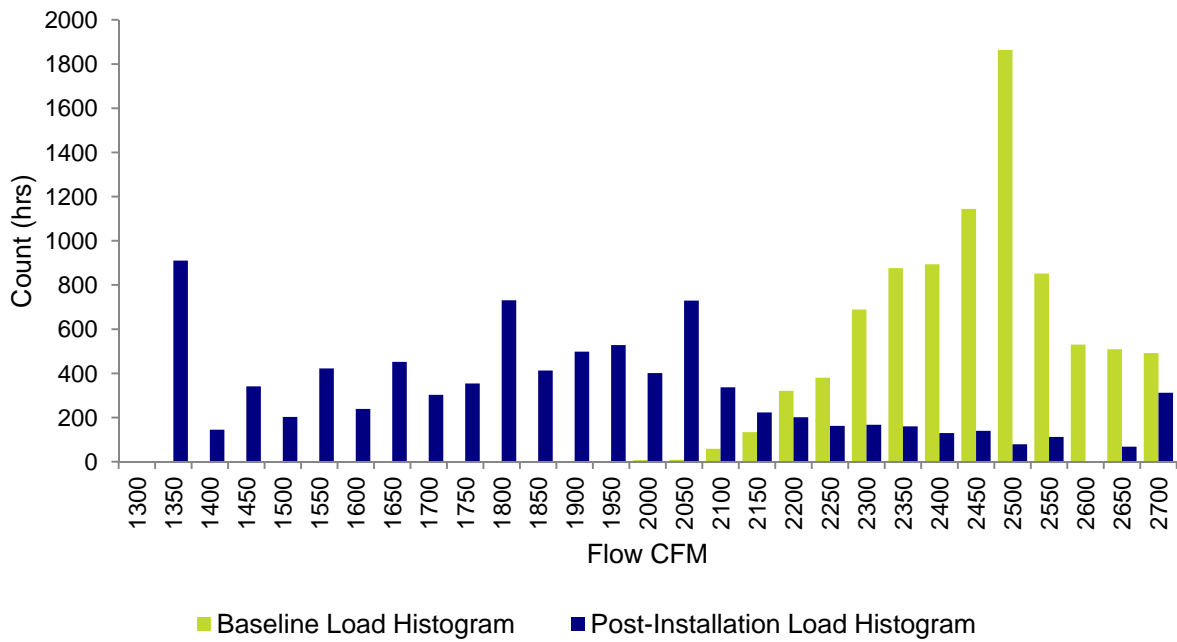

### 7.4.3. Algorithm

Both the baseline and post-installation load characteristics (load and schedule) were measured. The hours of operation at various loads were measured for a two-month time period in both the baseline and the post.

Annual energy use is calculated by Equation 4, from Table 3-3 using the histogram of flow from the post-installation case:

■ **Equation 4:** 
$$kWh_{saved} = \sum_i [kW_{base,i} \cdot HRS_{base,i} - kW_{post,i} \cdot HRS_{post,i}]$$

### 7.4.4. Annual Savings

The calculations of energy savings are shown in Figure 7-20.

**Figure 7-20: Savings Calculations**

Flow		Baseline		Post-Installation		Savings
<i>Bin</i>	<i>kW</i>	Energy		Energy		<i>kWh</i>
		<i>Frequency</i>	<i>kWh</i>	<i>Frequency</i>	<i>kWh</i>	
1300	106.2	0.0	-	0.0	-	-
1350	110.3	0.0	-	910.0	100,395	(100,395)
1400	114.4	0.0	-	145.0	16,590	(16,590)
1450	118.5	0.0	-	341.0	40,407	(40,407)
1500	122.6	0.0	-	203.0	24,884	(24,884)
1550	126.7	0.0	-	422.0	53,454	(53,454)
1600	130.8	0.0	-	239.0	31,250	(31,250)
1650	134.8	0.0	-	452.0	60,948	(60,948)
1700	138.9	0.0	-	303.0	42,095	(42,095)
1750	143.0	0.0	-	354.0	50,627	(50,627)
1800	147.1	0.0	-	731.0	107,530	(107,530)
1850	151.2	0.0	-	413.0	62,440	(62,440)
1900	155.3	0.0	-	498.0	77,325	(77,325)
1950	159.4	0.0	-	528.0	84,141	(84,141)
2000	163.4	7.0	1,144	401.0	65,541	(64,397)
2050	167.5	9.0	1,508	729.0	122,129	(120,621)
2100	171.6	59.0	10,125	337.0	57,835	(47,709)
2150	175.7	134.0	23,544	223.0	39,182	(15,637)
2200	179.8	321.0	57,712	201.0	36,137	21,575
2250	183.9	380.0	69,872	162.0	29,788	40,085
2300	188.0	689.0	129,505	167.0	31,389	98,115
2350	192.0	876.0	168,233	160.0	30,727	137,505
2400	196.1	894.0	175,342	130.0	25,497	149,845
2450	200.2	1144.0	229,050	140.0	28,031	201,019
2500	204.3	1864.0	380,824	79.0	16,140	364,684
2550	208.4	852.0	177,549	112.0	23,340	154,209
2600	212.5	530.0	112,613	0.0	-	112,613
2650	216.6	509.0	110,231	68.0	14,726	95,504
2700	220.6	492.0	108,559	312.0	68,842	39,717
			1,755,810		1,341,391	414,420



## 8. References and Resources

- ASHRAE. 2010. *ASHRAE Guideline 2-2010 – Engineering Analysis of Experimental Data*. Atlanta, Ga.: American Society of Heating, Refrigerating and Air-Conditioning Engineers.  
Purchase at: [http://www.techstreet.com/cgi-bin/detail?product\\_id=1730629](http://www.techstreet.com/cgi-bin/detail?product_id=1730629).
- ASHRAE. 2002. *ASHRAE Guideline 14-2002 – Measurement of Energy and Demand Savings*. Atlanta, Ga.: American Society of Heating, Refrigerating and Air-Conditioning Engineers.  
Purchase at: [http://www.techstreet.com/cgi-bin/detail?product\\_id=1645226](http://www.techstreet.com/cgi-bin/detail?product_id=1645226).
- Haberl, J.S. and C. H. Culp. 2003. *Review of Methods for Measuring and Verifying Savings from Energy Conservation Retrofits to Existing Buildings*, report no. ESL TR-03/09-01, Sept. 2003, rev. 2005. College Station, Tex: Engineering Systems Laboratory, Texas Engineering Experiment Station, Texas A&M University System.  
Available at: <http://repository.tamu.edu/handle/1969.1/2049>.
- IPMVP. 2010. *International Performance Measurement and Verification Protocol Volume 1: Concepts and Options for Determining Energy and Water Savings*. EVO 10000 – 1:2010. Washington, D.C.: Efficiency Valuation Organization.  
Available at: [http://www.evo-world.org/index.php?option=com\\_form&form\\_id=38](http://www.evo-world.org/index.php?option=com_form&form_id=38).
- NIST/SEMATECH. 2011. *Engineering Statistics Handbook (NIST/SEMATECH e-Handbook of Statistical Methods)*. Gaithersburg, Md.: National Institute of Standards and Technology.  
Available at: <http://www.itl.nist.gov/div898/handbook/index.htm>.

